

ED400 Concealed “In Floor” AUTOMATIC SWING DOOR Controller Installer’s Manual

Distributed by:

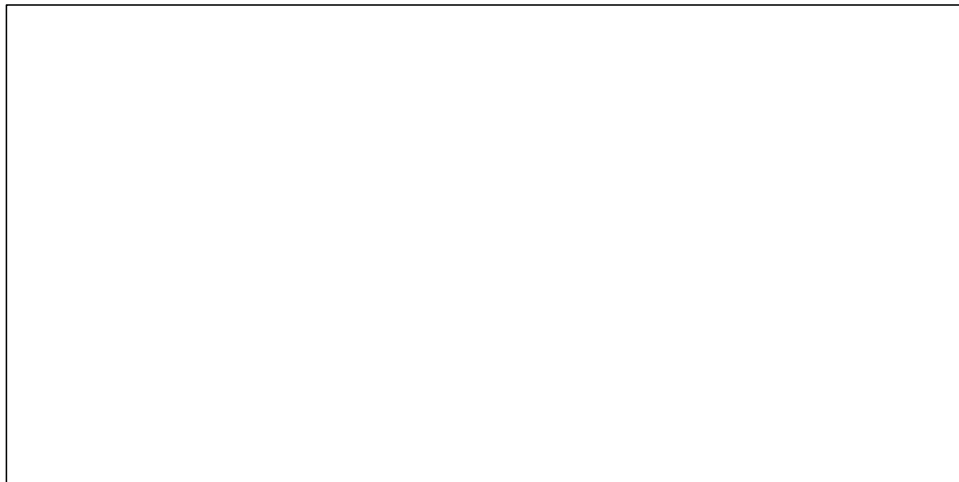

ED-400 SWING DOOR CONCEALED “IN FLOOR” OPENERCONTROLLER INSTALLER'S MANUAL

Rev0.56

INTRODUCTION	3
INSTALLATION	3
Operator installation	3
Controller installation	3
SET-UP	6
OPERATION	9
Opener Type	9
Selected Features	10
Program Switch	10
Unusual circumstances	10
User intervention	10
Presence	11
Obstacle	11
Alarm	11
MENU REFERENCE	11
Misc. Adjustments menus	13
Monitor Select and Monitor Values menus	15
TROUBLESHOOTING	16
Electrical	16
Troubleshooting tools	16
Particular situation Troubleshooting	18
SPECIFICATIONS	22
APPENDIX	23
WIRING	23
Switch wiring	23
Pairs of Doors	24
Operation	26
Restore factory defaults	26
Set-up without temporary stop	26
Cycle testing	26

INTRODUCTION

The ED400 is an electro mechanical, automatic opener, for single direction swing doors (left or right hand). The opener opens the door using electrical power, and closes it using a return spring. The manager may turn it Off, turn it On (automatic) or place it in Hold Open (to keep the door open indefinitely). When turned Off, or in the absence of power, it operates as a passive door closer. Its operation may be controlled by a variety of sensors.

This is the manual for just the controller.

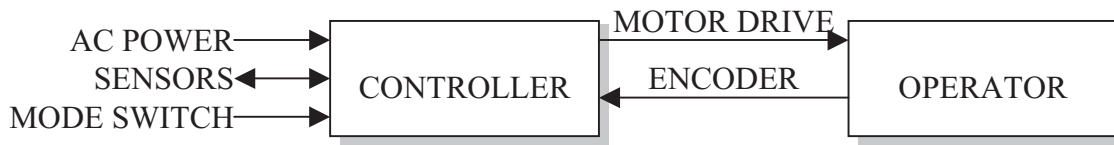

INSTALLATION

We'll first install the operator (and the header, surface mount), then the controller and its wiring, then the door (OCM) or the arm (surface mount).

Operator installation

Refer to the operator's manual for instructions on mounting it.



WARNING! When the operator is not connected to a controller, it may slam shut, endangering you and harming the adjustment bolt.

Controller installation

To install the controller, do the following:

Controller

- Install it in the cement case, using T-bolts to the bottom of the cement case, with the side with the display facing upwards.
- The controller is grounded through the AC power connector and the motor connector; there's no need for direct grounding from the controller's case.

Motor

- Connect the 3-screw, black terminal block at the end of the motor cable to the controller's "Motor" connector (on right side panel). The [appendix](#) has instructions on wiring the motor cable to a connector.
- Check that the motor is connected properly. Install the arm on the pinion, and rotate it in the opening direction; if that's hard to do, the motor is connected backwards. Let the arm go; if it slams closed, the motor is connected backwards. In either case, swap the back and red wires. Then test it again. For more information, see the troubleshooting section.

Encoder

- To report their position, the operator uses an encoder. Connect its cable to the controller's white "Encoder" connector, on the right side of the controller's front panel. The [appendix](#) shows how to wire this connector, if it isn't already wired.

Sensors

- Get power for any sensors that require it from any of the screws in the "+24" terminal block, and any of the screws in the "GND" terminal block. These are the 2, 8-screw, blue terminal blocks on the right end of the front panel.

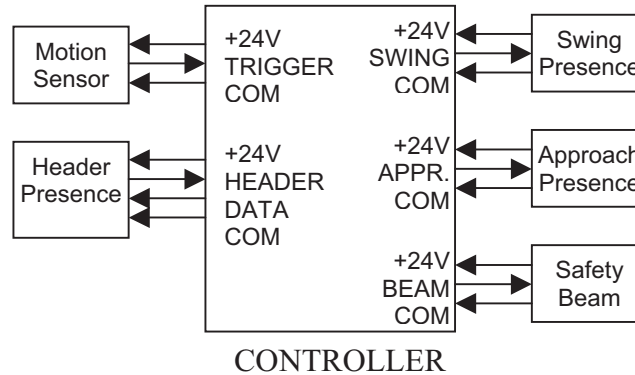

- The trigger device (motion sensor (radar) or other device) goes to the "TRIG" terminal. Connect its common to the Ground terminal, and, if required, connect its power to the +24 V terminal.
- The header (jamb) mounted presence sensor goes to the "HEADER" terminal. Connect its common to the Ground terminal, and its power to the +24 V terminal. A dual zone sensor (such as the BEA DK-12) needs a "DATA" signal: connect it to the "DATA" terminal.
- The door-mounted, approach side presence sensor goes to the "APPR" terminal. Connect its common to the Ground terminal, and its power to the +24 V terminal.
- The door-mounted, swing side presence sensor goes to the "SWING" terminal. Connect its common to the Ground terminal, and its power to the +24 V terminal.
- If the installation has a safety beam, connect it to the "BEAM" terminal. Connect its common to the Ground terminal, and its power to the +24 V terminal.

Electric lock

The controller may power an electric strike plate (a.k.a. electric lock), through a relay or access control device. The [appendix](#) has more information.

Program Switch

- This is the On/Auto/Hold-Open switch
- Install the switch by the door
- Route its cable to the controller
- Cut off excess cable, strip the 3 wires
- Connect the 3 wires to the removable, 3-screw terminal block in the lower right corner of the controller's front panel. (Note that when you press one end of a rocker switch, it connects the middle terminal to the one on the opposite end; this could be counterintuitive.)
 - The common wire (black) goes to the middle screw.
 - The lower wire when the switch is mounted (white) goes to the upper screw (this is the Hold-Open wire).
 - The upper wire (red) goes to the lower screw (this is the Off wire).

Emergency: Fire and Break-Out

- The controller comes from factory with a jumper between the "FIRE" and "GND" terminals, and between the "BRK.O." and "GND" terminals. If either one of these jumpers is open or missing, the controller will not operate: it will flash an "Emergency" alarm.
- If the installation requires it, remove the jumper between the "FIRE" and "GND" screws and wire a fire alarm to those two screws. The fire alarm output must be a normally closed, dry contact.
- If the door has a breakout mechanism, with a switch, remove the jumper between the "BRK.O." and "GND" screws and wire the switch to those two screws. Use the normally closed contacts of the switch.

AC Power

- Connect power to the controller's "Power" connector (on right side panel). See the [appendix](#) for the wiring.
 - Make sure the AC power source is off.
 - Route the AC power cable to the opener
 - Cut off excess cable, strip the 3 wires
 - Unplug the 3-screw, green terminal block from the controller
 - Connect the 3 wires to the terminal block
 - Plug the terminal block to the controller



WARNING! Do not plug the AC power into the MOTOR connector, or the controller will be damaged! The AC power plugs provided are keyed so that they cannot be plugged into the Motor connector. However, if you use other plugs, nothing prevents you from plugging them in the wrong connector.

Door or arm installation

Refer to either the Surface Applied or Overhead Concealed Mount, ED400 Installation Instructions on mounting the door or the arm.

If the installation procedure requires that the operator's pinion be moved in the open position, you may use the controller to do so, as follows.

- Turn on AC power to the controller.
- Set the Mode switch to the Off position.
- Turn the "Selector" knob to the "Learn" position.
- Set the Mode switch to the "On" position
- The pinion will start turning slowly in the open direction, and stop indefinitely at Back-Stop.

SET-UP

User Interface

The controller user interface is quite intuitive. It includes a display and two rotary switches (knobs).

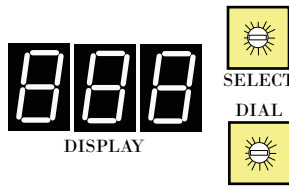

Use the top knob ("SELECTOR") to select the function.

Use the bottom knob ("DIAL") to change a setting.

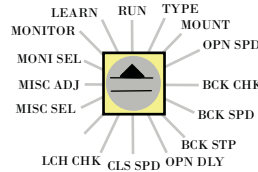
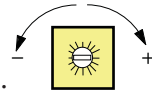

The display shows letters using only 7-segments, so some letters may not be obvious.





Quick Start

In this quick-start we'll use only a few of the available menus. For a complete list of settings see the [Menu Reference](#) section.

To adjust the opener, do the following (for an alternate procedure, see "[Set-up without temporary stop](#)" in the Appendix):

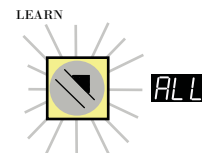
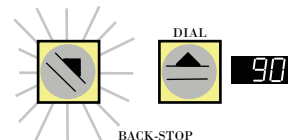
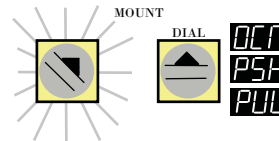
- Turn on the controller
 - Apply AC power to the controller.
 - The controller will light up.
 - Set the Program Switch in the "Off" position.
- Indicate the door mount.
 - Turn the Selector knob to the position "Mount"
 - Turn the Dial knob to select
- Prepare to teach the opener where you want Electrical Back-Stop to be.
 - If the operator has an internal hard-stop in the open position, set it to keep the door from banging at the open end, and, at the same time as wide as possible, so that the door can reach the desired Back-Stop position (the Electrical Back-Stop) without hitting the operator's hard stop.
 - Turn the "Selector" knob to the "Back-Stop" position. The display should show "90", the programmed Back-Stop angle in degrees. If not, or if you want the Electrical Back-Stop to be elsewhere, change it with the Dial knob. Get ready to stop the door, such as with your foot, at the desired Electrical Back-Stop.
- Do a learn cycle.
 - Turn the "Selector" knob to the "Learn" position. The display shows the Learn State. If it doesn't say "ALL" (meaning it needs a full learn), turn the "Dial" knob counter-clockwise until it does.



- Move the Program Switch from the "Off" position the "Auto" position.
- The door stays closed for 10 seconds to let you get out of its way.
- Then the door will start opening slowly.
- Temporarily, place a hard stop (such as your foot) at the desired Back-Stop.
- Wait for the door to touch that stop and start closing. (Do not let anything else stop the door beforehand, else the wrong Back-Stop will be learned.) **It is important that the door is stopped in the desired Back-Stop position during the full learn cycle.**
- Remove that stop.
- The door will close slowly to Latch-Stop.
- **Get out of the way!**
- The door will **slam open** (to measure its inertia), then close.
- The display will show "CyC", meaning that the opener  needs a cycle learn.
 - The door will cycle open and closed at normal speed.
- Then the display will show "Rdy", meaning that it no  longer needs a cycle learn and it is ready.
- The door will continue cycling open and close, non-stop, until you place the Program Switch in the Off position.



Note that the opener has **reduced obstacle detection** while learning: **do not interfere with the door!**

Basic Adjustments

- Adjust the opener's operation. You can do this during a learn cycle (as the door is cycling open and closed). Or you can do this later; but if the parameter affects the door motion, you'll have to do a new learn cycle.
 - Turn the Selector knob to the position for the parameter you want to change:
 - Open speed to Back-Check
 - Back-Check angle (this is the one you'll want to play with first)
 - Back-Stop angle (hint: place the Program Switch in Hold Open to keep the door at Back-Stop, then adjust this parameter and watch the door move to that angle)
 - Close Delay
 - Closing speed to Latch-Check
 - Latch -Check angle
 - The display will show the present value for the selected item`
 - Use the Dial knob to change that value
 - If not already doing learn cycles, start them.

This table lists the basic settings.

Position of "Selector" knob Type	Function of "Dial" knob Opener Type	Display	Units
Mount	Select door mount	"L.E.": Low Energy, "P.A.": Power Assist; "Ful": full power Use "OCN" Setting	
Open Speed	increment/decrement	Opening speed to Back-Check	°/s
Back-Check	increment/decrement	Back-Check angle	°
Back-Speed	increment/decrement	Speed reaching Back-Check	°/s
Back-Stop	increment/decrement	Back-Stop angle	°
Close delay	increment/decrement	(a.k.a.: "Hold Open Time") Time at Back-Stop	s
Coarse speed	increment/decrement	Max closing speed to Latch-Check	°/s
Latch-Check	increment/decrement	Latch-Check able	°
Latch-speed	increment/decrement	Max closing speed to Latch-Stop	°/s

Triggers are enabled while the Selector knob is in the Run or Monitor value position, and disabled otherwise.

For more information on these items see the [Menu Reference](#) section.

- Test full operation. When you're happy with the cycle, stop the Learn Cycle.
 - Set the Program Switch in the "Off" position. The door will stop cycling.
 - Turn the "Selector" knob to the "Run" position. The display shows the present State of the opener. If there's an exception, it will show a code for it.
- Test the opener's operation with the sensors

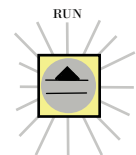

Advanced adjustments

While the basic settings are typically sufficient to set-up the opener, additional ones are available through the Misc Menus, such as:

- Push-and-go
- Power Hold
- Obstacle detection sensitivity

For a complete list of settings see the [Menu Reference / Misc Menu](#) section.

Position of "Selector" knob	Function of "Dial" knob	Display	Units
Misc-select	Select a miscellaneous setting to be adjusted	Code for the selected setting	-
Misc-adjust	Adjust the selected miscellaneous setting	Value of the selected setting	-

These settings are selected and adjusted indirectly, in two steps, with the Selector and Dial knobs.

- Turn the "Selector" knob to the "Misc Select" position.
- Turn the "Dial" knob until the desired setting is shown in the display.
- Turn the "Selector" knob to the "Misc Adjust" position. The display will show the present value of that setting
- Turn the "Dial" knob to adjust the value of that setting.

Monitoring

For troubleshooting purposes, the controller displays its Program State when the Selector knob is in the Run position, and its Learn State when the Selector knob is in the Learn position. The state and value of many more variables can be seen through the Monitor menus, such as:

- The Help display, showing what the opener is waiting for
- The number of cycles
- A Log of recent events
- The door angle and speed

For a complete list see the [Menu Reference](#) section.

Position of "Selector" knob	Function of "Dial" knob	Display	Units
Monitor Select	Select variable to be monitored	Code for variable monitored	-
Monitor Value	Depends on variable	Value of selected variable	-

To monitor one of those variables:

- Turn the "Selector" knob to the "Mon Select " position.
- Turn the "Dial" knob until the desired variable is shown in the display.
- Turn the "Selector" knob to the " MonitorValue" position. The display will show the present value of that variable.
- Usually the Dial knob has no function, though in some cases it can be used to get additional information.

OPERATION

The opener's behavior depends on

- Whether there's AC power,
- The Opener Type
- Any selected features
- The position of the Program Switch

AC power

No AC power

When there's no AC power, the controller places a passive brake across the motor leads, to slow it down when closing. The user may use the door manually. The door closes very slowly. The pinion speed is constant (therefore, for surface mount, the door speed isn't constant). There is no Latch-Check nor Back-Check (so the user could slam the door against the open hard stop). The speed is sufficiently slow that the time closing through Latch-Check meets A.N.S.I. specs.

AC Power is OK

When there's power, the controller is ON, even if the ProgramSwitch is in the Off position. It disables the passive brake, and instead it controls the motor directly. In this case, the opener's behavior depends on

- the Opener Type
- any selected features
- the position of the Program Switch

Opener Type

Full Power

When the user triggers the opener (for example, by walking towards a motion detector), the door opens, stays open for a while, then closes. If, while closing, another user retriggers the door, the door starts reopening.

Low Energy

This is the same as Full Power, but the installer must adjust some parameters for slower operation. To select this, the "Low Energy" switch must be in the "ON" position.

Power assist

When the user triggers the opener, the opener helps the user, so that the user may open the door with very little force; after a while, the door closes.

Selected Features

Push-and-go

If this feature is on, and if the Program Switch is in Auto, the user may also trigger an opening by starting to open the door by hand. Also, if the door is closing, and the user reopens it manually, the opener is retriggered. Note that if the user simply stops the closing door, the opener will consider that an obstacle, not a Push-and-go trigger.

Program Switch

At any given time, the opener may be in one of 3 modes, based on the position of the ProgramSwitch:

- Off
- Auto
- Hold-Open

Off

The opener emulates the operation of a hydraulic passive door closer (except that, when the door is closed, it may press against the hard-stop). The user may use the door manually; there's no Power Opening, nor holding the door open. (**Again:** with the Program Switch in the Off position, the opener is actually on; it's just that it doesn't open the door nor assist the user.) In the simplest case, the door starts at Latch-Stop; a user may open the door manually, and then release the door; then, the closer lets the door close.

Auto

The opener opens or assists the user automatically (though the user may still use the door manually). In the simplest case, the door starts at Latch-Stop; the opener detects that a user is approaching, and opens the door and holds it at the Back-Stop; then, the closer lets the door close. If, while closing, the opener detects a new user, it reopens the door. If a user opens the door manually, then the opener behaves as it does in the Off mode. If the door encounters an obstacle (while opening or closing), or a presence is detected, the opener stops the door; then the opener either opens or closes the door. In the simplest case, the door starts at Latch-Stop; when a user triggers the opener, the opener helps the user as she opens the door; then, the closer lets the door close. If another user retriggered the opener as the door is closing, the opener returns to helping the user. If, while closing, the door encounters an obstacle, the opener stops the door; then the opener lets the door close. If a user opens the door manually, then the opener behaves as it does in the Off mode.

Hold-Open

The opener opens the door and holds it open.

Unusual circumstances

User intervention

The way the opener responds to user intervention depends on what the door is doing at the time, and other factors.

Closed, Off Mode or Push-and-Go Off - The opener lets the user open the door against the force of the return spring. As soon as the user lets go of the door, it starts closing.

Closed, Auto Mode and Push-and-Go On - If the user opens the door manually, the door opens.

Opening full speed - If the user tries to open the door faster than the opener wants to, the opener resists, trying to maintain speed. If the user tries to force the door closed, the opener considers it an obstacle (see later).

Creeping open - If the user tries to open the door faster than the opener wants to, the opener resists lightly; as soon as the user lets go of the door, it finishes opening the door. If the user tries to force the door closed, the opener considers it an obstacle (see later).

Open - If the user opens the door away from Back-Stop, the opener fights against it, and tries to return the door to Back-Stop. After some time, to protect the motor, the opener starts a Over-Current alarm and shuts down.

Closing, Off Mode or Push-and-Go Off - If the user reopens a closing door, the opener lets her do so, working against the force of the return spring. As soon as the user lets go of the door, it starts closing. If the user forces the door to close faster than the opener wants to, the opener reverts to passive closing, until the door reaches Latch-Stop.

Closing, Auto Mode and Push-and-Go On - If the opener is retriggered the door reopens. If the user forces the door to close faster than the opener wants to, the opener reverts to passive closing, until the door reaches Latch-Stop.

Presence

The opener may detect people or objects in the proximity of the door. In that case, the opener modifies its behavior to avoid hitting anyone or anything in its path.

Before a Power Opening - The opener waits for the swing area to be clear.

During a Power Opening - The opener stops the door before moving again.

Before closing - The opener restarts the Closing Delay.

While closing, Auto Mode - The opener stops the door before moving again.

While closing, Off Mode - The door keeps on closing.

Obstacle

The opener detects if someone or somebody slows down or even stops the door. This includes the situation of the door being locked, or propped open with a door stop.

During a Full Speed Power Opening - The door stops, waits for a bit, then usually it creeps open.

While creeping open - The door immediately re-closes.

While closing, Auto Mode - The door stops, waits for a bit, then usually it creeps open.

While closing, Off Mode - The door just rests against the obstacle.

Alarm

If the opener detects certain alarm conditions, it stops running. Users may still use the door manually. The controller flashes a code for the Alarm (the Selector knob must be in the RUN position). The code is also added to the log (Mon Sel / Log; Mon Val) Alarms are cleared by turning the Program Switch to Off and back to Auto.

MENU REFERENCE

The controller offers a menu of 15 items. The Selector knob is used to select one of them. Two of those items offer dozens of additional submenus.

Position of "Selector" knob Type	Function of "Dial" knob Opener Type	Display	Units Type
Help	-	"L.E.": Low Energy, "P.A.": Power Assist; "Ful": full power	
Mount	Select door mount	Why the door won't move	
Open Speed	increment/decrement	Use "OCN" Setting	
Back-Check	increment/decrement	Opening speed to Back-Check	°/s
Back-Speed	increment/decrement	Back-Check angle	°
Back-Stop	increment/decrement	Speed reaching Back-Check	°/s
Close delay	increment/decrement	Back-Stop angle	°
		(a.k.a.: "Hold Open Time")	s
		Time at Back-Stop	
Close speed	increment/decrement	Max closing speed to Latch-Check	°/s
Latch-Check	increment/decrement	Latch-Check angle	°
Misc-select	Select a miscellaneous setting to be adjusted	Code for the selected setting	2
Misc-adjust	Adjust the selected miscellaneous setting	Value of the selected setting	2
Monitor-Select	Select variable to be monitored	Code for variable monitored	3
Monitor Value	Depends on variable	Value of selected variable	3, T
Learn	Downgrade the Learn State	The Learn State	4

Notes:

- 1) Leave in this position during normal operation
- 2) See Misc. Settings table
- 3) See Monitor table
- 4) Place here to do a learn cycle. At next power-up, does learn the appropriate learn
- T) In this position the trigger input is enabled

When selecting an item with the Selector knob, the display shows a code for that item, dimmed, for 1/2 second, then it shows the value for that item. For example, if you turn the Selector Knob to the Back-Stop position, the display shows **90** dimly for 1/2 second, and then **65**, the selected Back-Stop angle.

Run menu

Usually, the "Run" menu displays a code for the State of the opener. See the Program State section, later. However, if there is an exception, the Run menu flashes a code for the exception; it does so from the moment when it occurs, until the next opening cycle starts. You can also stop the flashing code by turning the Dial knob. See the "Events" section, later, for description of the Exception codes.

Type menu

This menu displays a code for the mount of the door and lets you select it. If you change this, you must do a full learn afterwards.

Mount		
LE	Low Energy	The "Low Energy" switch must be On for this option to be available
PA	Power Assist	
FUL	Full Power	



It is up to you, the installer, to make sure that the door doesn't violate A.N.S.I. standards! The opener does not ensure that the door moves within A.N.S.I. limits:

- Nothing keeps the installer from selecting the wrong setting in this menu.
- Nothing keeps the installer from setting the operating parameters in such way that the door moves faster than what the applicable BHMA/ANSI Standards allows.

Mount menu

This menu displays a code for the mount of the door and lets you select it. Use "OCM" setting for "IN FLOOR" mounting.

Mount		
OCM	OCM	Overhead concealed (direct drive)
PSH	Push	Push (scissor arm) surface mount
PUL	Pull	Pull (track) surface mount

Open Speed menu

This menu displays and lets you set the opening speed of the door during a Power Opening, up to Back-Check (in °/s). Use this adjustment to ensure that the opening time is lower than what A.N.S.I. specifies (lower values in Low Energy openers). If you change this, you must do just a cycle learn afterwards.

Back-Check menu

This menu displays and lets you set the Back-Check angle (in °). During a Power Opening, after this angle the door will slow down. The rate of deceleration is set by the "Deceleration" menu, described later. If you change this, you must do just a cycle learn afterwards.

End-Speed submenu

This submenu is used to display and set the minimum speed (after it slows down) at which the door reaches the Back-Stop, in °/sec.

Back-Stop menu

This menu displays and lets you set the Electrical Back-Stop angle (in °). During a Power Opening, this is where the door stops. This should be less than the mechanical Back-Stop (which may be set by the operator, or by where the door would encounter a physical stop). You can use it in 2 ways:

- Before a full learn, use it to tell the controller at what angle you'll stop the door.
- Use it to change the opening angle. (Hint: put the Program Switch in "Hold-Open" and change the setting, while watching the door follow your setting. You can do this any time the Learn State is "Ready", even during a learn cycle.) If you change this, you must do a cycle learn afterwards.

Close Delay menu

This menu displays and lets you set the minimum time that the door stays at Back-Stop during a Power Opening cycle (in °) (a.k.a.: "Hold-Open Time"). This is also the minimum time that the opener assist the user during an assist opening cycle. In Low Energy openers, you may need to extend this time to meet A.N.S.I. specs. This is **not** the time that the door stops after a presence or an obstacle: that's the Obstacle delay. If you change this, you must do just a cycle learn afterwards.

Close Speed menu

This menu displays and lets you set the maximum closing speed of the door, down to Latch-Check (in °/s). This is applicable regardless of how the door was opened (manually, or automatically). Use this adjustment to ensure that the closing time to Latch-Check is lower than what A.N.S.I. specifies (lower values in Low Energy openers). If you change this, you must do just a cycle learn afterwards.

Latch-Check menu

This menu displays and lets you set the Latch-Check angle (in °). While closing, below this angle the door will slow down. This is applicable regardless of how the door was opened (manually, or automatically). If you change this, you must do just a cycle learn afterwards.

Misc. Adjustments menus

These 2 menus work together to handle many minor settings. The first one is used to select an item, and the second one to display its value and to adjust it.

Misc. submenu item	Function of "Dial" knob	Display	Units, notes
HLd - Power	Hold increment/decrement	"OFF": passive; or motor current that holds door closed	A
PnG - Push-&-Go	Turn feature On or Off	"nO"; normal "yES": pressing on door starts a cycle	-
OOB - Open Obstacle	increment/decrement	If actual current > expected current by this amount: opening obstacle	A
COB - Close Obstacle	increment/decrement	If actual current < expected current by this amount: closing obstacle	A
UAL - Wall Mask	increment/decrement	Door angle beyond which the swing side sensor is ignored	°
OPd - Lock open delay	increment/decrement	"OFF": normal, or delay before opening	s
OCd - Occupied delay	increment/decrement	Delay after obstacle or after the area clears before moving again	s °/s ²
dEC - Deceleration	increment/decrement	Deceleration after Back-Check	-
PCE - Power Close Engaged	Turn feature On or Off	"nO" or "yES" "nO" is default after reset	-
PCA - Power Close Anlge	increment/decrement	OFF, 1-30 degrees "20 degrees" is default after reset	-
PCd - Power Close Time Delay	increment/decrement	00.1-10 seconds "4 seconds" is default after reset	-
PCC - Power Close Current	increment/decrement	OFF, 0.01-1.00 Amps "1.00 Amps" is default after reset	-
CLC - Power Boost	increment/decrement	OFF, or 0.01-1.00 Amps "0.50 Amps" is default after reset	-
rSE - Reset / restore	Reset the controller / Restore factory defaults	"nO": normal "yES": restore factory defaults	-

Items that use a numeric value show **OFF** instead of '0'. Features show **YES** or **NO**.

Power Hold submenu - **HLd**

If the door has a hard-stop at Latch-Stop, the opener may use additional force to press the door against the stop. This submenu is used to select the amount of that force, in terms of motor current (in Amps). At its minimum, this current is 0 (the door is held against the hard stop just by the return spring), and the display shows "OFF".

Push-and-Go submenu - **PnG**

This submenu is used to turn on or off the Push-and-Go feature, and to display the present selection.

- **NO** If the user opens the door by hand, or reopens a closing door, the opener lets him/her do so, working against the return spring.
- **YES** If the user opens the door by hand, the opener opens the door. If the user reopens a closing door by hand, the opener reopens the door.

Opening Obstacle submenu - **OOB**

This submenu is used to display and set the Opening Obstacle threshold (in Amps). Higher values mean less sensitivity to obstacles.

Closing Obstacle submenu - **COB**

This submenu is used to display and set the Closing Obstacle threshold (in Amps). Higher values mean less sensitivity to obstacles.

Wall Mask Angle submenu - **WAL**

When opening, beyond a certain angle, a door-mounted, swing-side sensor may see a wall and give a false reading. This submenu is used to display and set the door angle (in degrees) beyond which that sensor is ignored.

Lock Opening delay submenu - **OPd**

If an electric strike plate (electric lock) is used, it may be necessary to wait for it to retract, before opening the door. This submenu is used to display and set that delay, in seconds. If that delay is zero, the display shows "OFF".

Occupied delay submenu - **OCd**

This submenu is used to display and set how long (in seconds) a door stops after it encounters an obstacle or presence, before it resumes moving.

Deceleration submenu - **DEC**

This submenu is used to display and set how quickly the door slows down after Back-Check, in $^{\circ}/\text{sec}^2$. (A higher number means faster slowing down). If you change this, you must do just a cycle learn afterwards.

Power Close Engaged - **PCE**

This adjustment turns the **Power Close** On or Off

Power Close Angle - **PCA**

When power boost closing is needed only in the last 30° of door closing, this is used to set angle desired.

Power Close Time Delay - **PCd**

This adjusts the time delay before the operator starts power boost after encountering an obstruction.

Power Close Current - **PCC**

This adjusts the closing force during the swing path of "PCA".

Power Boost - **PLL**

When power boost closing is needed throughout the entire closing swing of the door the closing force is adjusted here.

Reset / restore submenu - **RSE**

This submenu is used to restore the factory defaults (including clearing the password) ○ Turn the Dial knob clockwise. The controller will reload the factory defaults; the program will restart from the beginning; the display will show the start-up logo. (Just to force a new learn cycle, use the "Learn" menu instead.)

Monitor Select and Monitor Value menus

These 2 menus work together to display the value of many minor items. The first one is used to select an item, and the second one to display its value.

Misc. submenu item	Function of "Dial" knob	Display	Units, notes
LOG - Log	Select one of the 16 events in the log	Code for the event	-
ObS - Obstacles	Clear it	Number of obstacles since the last cleared	-
CYC - Cycles	Scroll the display	Number of openings cycles since the controller was manufactured	-
rEL - Release	-	Software release level	-
Ang - Angle	-	Angle of door	°
Cur - Current	-	Motor current (absolute value)	A

Items that use a list show a code for their value.

Log submenu - **LOG**

The controller logs the last 16 unusual events. This submenu is used to display the log of events. Normally it shows the most recent event. Turning the Dial knob counter-clockwise (back in time) selects the previous events; and vice-versa. Once one end of the log is reached, turning the Dial knob further in the same direction will have no effect. The codes for the events are described later in the Event Codes section.

Obstacles submenu - **ObS**

Each time the door meets an obstacle, the controller increments a counts, up to 255. This submenu is used to display that count. Turning the Dial knob counter-clockwise clears that count.

Cycles submenu - **CYC**

This submenu is used to display the number of full opening and closing cycles that the controller did, up to 9,999,999. This is not necessarily the number of cycles that the operator did, as the controller may have been mated to another operator at some other time. If the door is reopened while closing, this doesn't count as an additional cycle. If the controller is powered down, it resets the units digit (for example, if the count was 123 cycles, upon restoring power to the controller, it will show 120 cycles). As the display has only 3 digits, the Dial knob may be used to scroll the number of cycles, so that the rest of the number maybe viewed (for example, if the number of cycles is 12345, initially the number ".345" will be shown; turning the Dial knob one step clockwise will scroll the number to the right, and "2.34" will be shown; turning the knob further will show "12.3", "012." and "001".

Release submenu - **rEL**

This submenu is used to display the software release in the controller.

Angle submenu - **Ang**

This submenu is used to display the approximate door angle, in degrees.

Current submenu - **Cur**

This submenu is used to display the motor current, in amps.

TROUBLESHOOTING

Electrical

Fuse replacement

The controller has 2 fuses, one on the AC line input, one on the motor output. If the input fuse blows, the controller is completely off (no display). If the output fuse blows, the controller comes on, but there's no motor drive. Regardless, the passive braking keeps on working, because it's directly connected to the motor connector.

This is the fuse information:

F1	Line input fuse	Input plug	5 x 20 mm	2.0 A, fast
F2	Motor fuse	Motor-plug	5 x 20 mm	4.0 A, fast

To replace a fuse:

- Disconnect the AC power
- Unscrew the appropriate fuse holder cap
 - Right side for the motor fuse
 - Left side for the line input fuse
- Replace the fuse with an identical one
- Close the fuse holder
- Reconnect the AC power

Plugging AC to Motor Connector

Plugging AC power into the Motor connector will damage the controller. The AC power plugs provided with the controller are keyed in such way that you can't do so. However, if you use other plugs, nothing prevents you from doing so.







Troubleshooting tools

For troubleshooting purposes, the controller displays:

- the state of its inputs, with LEDs
- the Learn State (when the Selector knob is in the Learn position)
- the present exception, if any (when the Selector knob is in the Run position)
- recent exceptions (Log menu)



Input LEDs

Each sensor input line, and the Fire and Breakout lines, have LEDs to indicate their status. This is what it means when the LEDs are lit:

LED	Reason for being lit	
	Trigger	The trigger (radar) sensor is active, or this line is shorted to ground
	Pres	The approach-side sensor is active, or this line is shorted to ground
	Approach	The jamb-mounted sensor is active, or this line is shorted to ground
	Swing	The swing-side presence sensor is active, or this line is shorted to ground
	Beam	The light beam sensor is active, or this line is shorted to ground
	Break Out	The link between this line and ground is open, or the door is in breakout
	Fire	The link between this line and ground is open, or the fire detector is active



Output LEDs

Each output line has an LED a to indicate its status. This is what it means when the LEDs are lit:

LED	Reason for being lit
	Data A DK12 is connected to the controller, and the door is not closed, telling the DK12 to use the Open Pattern. (If no DK-12 is connected, the LED remains Off.)
	Lock The controller is driving an electriclock (whether or not a lock is present)

Learn State

In addition to the Program State, at any given time, the controller is in one of 3 Learn States.

Learn State		
	All	The opener needs to do a complete learn cycle
	Cycle	The opener needs to do just an opening and closing cycle
	Ready	The operator is ready



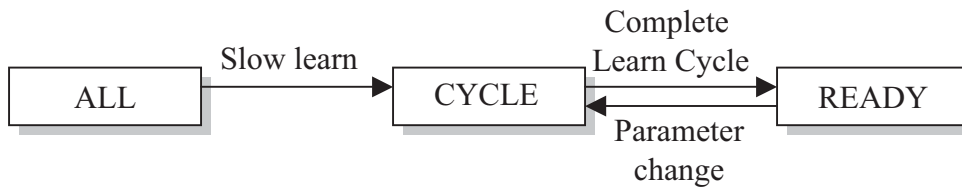











The controller is in the first two Learn States ("All" and Cycle") during set-up. From then on it's in the "Ready" State, ready to operate normally. If the installer changes an Operating Parameter, the controller reverts to the "Cycle" Learn State. After a complete learn cycle, the controller returns to the "Ready" State.



When the Selector knob is in the "Learn" position, the display shows the Learn State.

Event codes

If the controller detects an abnormal condition, it displays a code for it (when the Selector knob is in the "Run" position). The controller maintains a list of the most recent 16 significant events, which you can view with the Monitor function. The controller catches certain unusual Events, and stores them in the log. Some events are Exceptions. Exceptions are also displayed when the Selector knob is in the "Run" position (from the moment when they occur, until the next opening cycle starts).

Event		
	Not set-up	Not set-up
	Opening Obstacle	The door encountered an obstacle while opening
	Closing Obstacle	The door encountered an obstacle while closing
	Locked	The door encountered an obstacle while at Latch-Stop
	Swing	The swing-side, door mounted presence sensor was activated
	Emergency	An emergency link (smoke detector, breakout) was opened
	Motor	The motor is not connected
	Direction	The motor is wired backwards
	Time-out	A state lasted too long
	Bad value	A variable's value was outside its allowed limits. See next.
	Over-Heat	The motor overheated
	Over-Current	The motor current exceeded the maximum for too long
	Encoder	The encoder is not working, is disconnected, it has a broken wire
	Failure	The controller failed

Bad value

Due to unusual circumstances, an operating parameter may take a value outside its allowed limits. The controller constantly checks the operating parameter; if it finds a problem with their value, it logs the problem and restarts the program from scratch. After the **---** entry, the next 2 items in the log are the address of the variable, and the bad value. This table lists the addresses (N is the number shown in the log).

For example:

Position of DIAL knob	Display	Meaning
Fully CW (most recent)	PUP	Automatic Power-up after the bad value was detected
1 step CCW (previous)	140	The bad value: 140 degrees (*see below)
2 steps CCW	41	Address of the variable with the bad value: 41, which, form the previous table, we see is the Wall Mask Angle
3 steps CCW	bad	A bad value was detected
4 steps CCW (previous)	PUP	Previous power-up
Further CCW	---	No other event in the log

Particular situations

Power off: ease of motion

With the power off, the door should open easily and close slowly. If not, use this table to troubleshoot it.

Symptoms	Possible cause	Solution
The door is hard to open and slams shut.	The motor wiring is backwards.	Reverse the red and black wired in the motor connector.
The door is hard to open and closes very slowly.	Try disconnecting the motor cable. If that makes no difference, the operator is bad; if the door opens easily and slams shut, the controller is bad.	Replace the controller.
The door is easy to open and slams shut.	<ul style="list-style-type: none"> The motor is not wired to the controller (check the cable and the motor connector) The controller is bad The motor is bad 	<ul style="list-style-type: none"> Fix the wiring Try replacing the controller Replace the operator

Power off: time through Latch-Check

With the power off, the Passive Brake, inside the controller, limits the closing speed. The Passive Brake is not adjustable. The closing time from 10° to Latch-Stop should be 1.5 seconds or more, per BHMS/ANSI. For OCM applications, the door may close faster than that. If so, you only have 2 options: reducing the spring preload, or adding mechanical friction to the door.

Display is dark

The opener may not open the door for these reasons:

- There's no AC power to the controller
- The AC plug to the controller is disconnected
- The line input fuse (on the right side panel) is blown
- The software is hung up

Opener won't learn

To start a learn cycle, the following must happen:

- Power must be on
- There must not be an alarm
- The Selector knob must be in the Learn position
- The Program Switch must be moved to Off and Auto If the opener doesn't start the Learn Cycle, use the following table to troubleshoot it.

Action	Check	Solution
Move the Selector knob to the "RUN" position.	Is there a code flashing?	Check that code and see what it means in the Event Codes table. Solve it accordingly. Check that code and see what it means in
Move the Selector knob to the "MONI SEL" position. Turn the Dial Knob until you see "LOG".	Is there a code?	the Event Codes table. Solve it accordingly.

If the Learn Cycle starts, but then the display shows that the controller restarted (the display goes through the 3 opening logos), the controller believes that it found a problem. Use the Log to find out what that problem is. If the door will open and close slowly, but then not do anything else, it may be because you stopped the door too soon. Just do a new learn cycle, but this time make sure that you stop the door at the desired Back-Stop.

Opener won't open, manual opening is OK

The opener may not open the door for these reasons:

- The opener needs a learn cycle (probably because you changed a parameter that affect motion) – turn the Selector knob to the Learn position; if it doesn't say "Rdy", do a learn cycle
- The Program Switch is in the Off position – switch it to the Auto position
- The controller detected an alarm condition – place the Selector switch in the Run position; if an exception code is flashing, note the code; turn Off power to the opener; read about that failure in the troubleshooting section, and, if possible, correct the problem; try again.
- A wire from the Program Switch is shorted to ground
- The trigger source is not working, or it's not wired properly – in that case the Trig LED on the controller will not light up
- The software is hung-up – turn Off and On power to the opener In any case, look at the Help menu for a hint.

Opener keeps door open at Back-Stop

The opener may not open the door for these reasons:

- The Program Switch is in the Hold-Open position – move it to Auto
- There's a door stop holding the door open – try moving the door by hand
- The controller is receiving a trigger signal – see if the Trig LED is lit
- The controller is receiving a header presence signal – see if the Pres LED is lit
- The controller is receiving an approach presence signal – see if the Appr LED is lit
- The controller is receiving a safety beam signal – see if the Beam LED is lit
- A wire from the Program Switch is shorted to ground
- The delay is set very long and it hasn't yet expired

Opener pushes door hard against the Latch-Stop

This may happen for these reasons:

- The Power-Hold feature is on – troubleshoot why the trigger won't open the door
- There is a temporary soft failure – remove power to the controller and turn it back on
- If the problem persists, the controller may have forgotten some parameters – do a learn cycle
- If this happens as soon a power is applied to the controller, there is a hardware failure – replace the controller

Opener keeps door open against the operator's hard-stop

This may happen for these reasons:

- There is a temporary soft failure – remove power to the controller and turn it back on
- If the problem persists, the controller may have forgotten some parameters – do a learn cycle
- If this happens as soon a power is applied to the controller, there is a hardware failure – replace the controller

Opener stuck assisting

The opener may keep on assisting the user (the door can be moved in either direction with little effort) for these reasons:

- The controller is receiving a trigger signal – see if the Trig LED is lit
- The controller is receiving a header presence signal – see if the Pres LED is lit
- The controller is receiving an approach presence signal – see if the Appr LED is lit
- The controller is receiving an swing presence signal – see if the Swing LED is lit
- The controller is receiving a safety beam signal – see if the Beam LED is lit
- The delay is set very long and it hasn't yet expired
- A wire from the Program Switch is shorted to ground
- The trigger source is not working, or it's not wired properly – in that case the Trig LED on the controller will not light up
- The software is hung-up – turn Off and On power to the opener In any case, look at the Help menu for a hint.

Opener keeps door open at Back-Stop

The opener may not open the door for these reasons:

- The Program Switch is in the Hold-Open position – move it to Auto
- There's a door stop holding the door open – try moving the door by hand
- The controller is receiving a trigger signal – see if the Trig LED is lit
- The controller is receiving a header presence signal – see if the Pres LED is lit
- The controller is receiving an approach presence signal – see if the Appr LED is lit
- The controller is receiving a safety beam signal – see if the Beam LED is lit
- A wire from the Program Switch is shorted to ground
- The delay is set very long and it hasn't yet expired

Opener pushes door hard against the Latch-Stop

This may happen for these reasons:

- The Power-Hold feature is on – troubleshoot why the trigger won't open the door
- There is a temporary soft failure – remove power to the controller and turn it back on
- If the problem persists, the controller may have forgotten some parameters – do a learn cycle
- If this happens as soon a power is applied to the controller, there is a hardware failure – replace the controller

Opener keeps door open against the operator's hard-stop

This may happen for these reasons:

- There is a temporary soft failure – remove power to the controller and turn it back on
- If the problem persists, the controller may have forgotten some parameters – do a learn cycle
- If this happens as soon a power is applied to the controller, there is a hardware failure – replace the controller

Opener stuck assisting

The opener may keep on assisting the user (the door can be moved in either direction with little effort) for these reasons:

- The controller is receiving a trigger signal – see if the Trig LED is lit
- The controller is receiving a header presence signal – see if the Pres LED is lit
- The controller is receiving an approach presence signal – see if the Appr LED is lit
- The controller is receiving an swing presence signal – see if the Swing LED is lit
- The controller is receiving a safety beam signal – see if the Beam LED is lit
- The delay is set very long and it hasn't yet expired

Opening door bumps against the hard-stop

The controller learned the Electrical Back-Stop to be the same as the mechanical hard-stop. That is probably because either

- you didn't stop the door at the Electrical Back-Stop during the slow learning cycle, during initial set-up, or
- the hard-stop in the operator is set too far closed.

Back-Check or Latch-Check angles seem wrong

Move the door manually and compare the actual door angle with the angle displayed (turn the Selector knob to Monitor Select, turn the Dial Knob to select "AnG", turn the Selector knob to Monitor Value).

- If they do match, remember that the door slows down *before* Latch-Check.
- If they don't match, see the next paragraph.

Angle displayed doesn't match door angle

If the angles do match at Back-Stop:

- Check the setting for Door Mount in the controller.
- For surface mount doors, check the placement of the operator with respect to the doorhinge.
- For Push mounts, check the point where the arm is mounted to the door, and the angle of the arm when the door is closed.
- If all of these are correct, then the problem may be that the reveal is very different from the standard that was used to calculate the controller's parameters.

If the angles don't match anywhere:

- During initial set-up, the Back-Stop angle you specified in the controller was not the same as the angle where you stopped the door during the slow learning cycle. Do a new Full learn Cycle

DATA LED doesn't light

This LED lights if the door is anywhere but at Latch-Stop, and a DK-12 dual-zone sensor is properly connected. If this LED doesn't light when the door is open, it's probably because a DK-12 is not properly connected to the DATA line. You may test this LED by connecting the DATA line to Ground.

LOCK LED doesn't light

This LED lights if the controller is driving an electric lock (whether or not a lock is actually connected to the LOCK line). If this LED doesn't light, or is always lit, the problem is probably that the driver inside the controller was damaged by being improperly connected

SPECIFICATIONS

Main features

- Overhead Concealed Mount or surface mount (push or pull)
- Center pivot or offset hinges
- Complete: doesn't require a power-boost module, nor a brake box
- Hand is field reversible

Control inputs

- Seven sensor inputs (individual LEDs indicate status):
 - Trigger (radar, motion detector, push plate, access control, RF receiver...)
 - Header (jamb) mounted presence sensor
 - Door mounted, approach side presence sensor
 - Door mounted, swing side presence sensor
 - Safety beam presence sensor
 - Fire (Smoke alarm)
 - Breakout switch
- Input for Program switch (Off/Auto/Hold Open)
- All inputs, except for the Fire and Breakout inputs, are active low, compatible with:
 - dry contact
 - open collector
 - TTL
 - any signal up to 24 Vdc
- Fire and Breakout inputs are active open.

Control outputs

- Electric strike lock, open collector 100 mA max, 24 Vdc max. **not protected.** (requires additional relay, not included; requires external supply, not included, for electric locks other than 24 Vdc)
- Data (for dual zone sensors, such as BEA DK-12)
 - Door closed: open circuit (0 Vdc)
 - Door closing: 500 Hz square wave
 - Door opening or open: 12 Vdc unregulated, 100 mA source max

Control inputs/outputs

- Synch cable for side-by-side openers (part number DS2715-010)
 - RXD TXD.

Power

- Input: 115 Vac, 2 A Max
- Output: 24 Vdc, 0.8 A, unregulated, short circuit protected, for sensors and accessories

Safety

- Operates as a passive door closer in case of power failure or controller failure
- Smoke alarm and breakout switch input

Misc

- Operating air temperature -40 to 50 °C
- Small size: 8" wide x 4 " tall x 2.5" deep
- Microprocessor controlled, FLASH re-programmable, replaceable
- Two controllers may be synchronized for side-by-side doors
- Closed loop control

**APPENDIX
WIRING**

**Encoder / Cam Switch wiring
Encoder only**

the 4 wires from the encoder should already be connected properly to the 5-position connector. If you need to wire it, here is how.

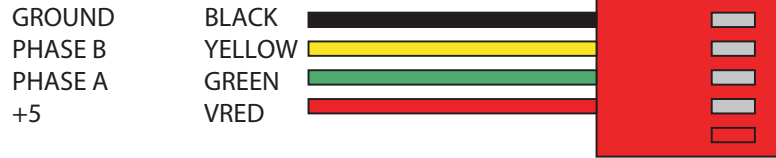

The 2 middle wires (Phase A and B, Yellow and Green) can be swapped without a problem: the software is smart enough to figure which way the motor is turning, and it interprets the 2 phases correctly.

Motor wiring

From the factory, the motor wires are already connected properly to their 2-screw terminal block. If you need to rewire it, here is how.

The red and black wires go to the other 2 screws, depending on the opening direction of the door. For CW opening (as seen from above – that's a right hand door), the back wire goes to the screw closest to the side of the box. For CCW opening (that's a left hand door), the red wire goes to the screw closest to the side of the box. The black wire goes to the opposite screw.

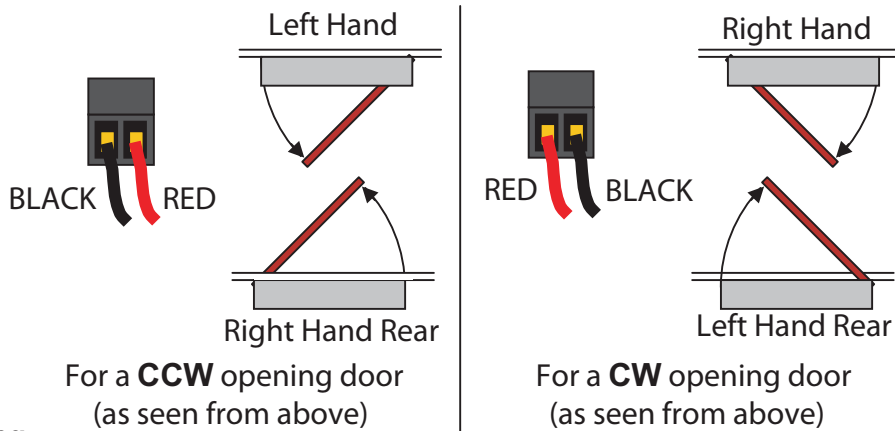

AC Power wiring

The green wire goes to the middle screw. When looking at wire openings, with the screws towards up, the line wire (usually black) goes the left hole, and the neutral (usually white) goes to the right one.

ELECTRIC LOCK

The controller may power an electric lock through a relay or access control device.

- If the installation has a 24 Vdc electric strike plate (a.k.a. electric lock), the controller is able to power it directly. For DC lock of other voltages, you will need a separate power supply. For AC locks, you will need a separate transformer and a relay.

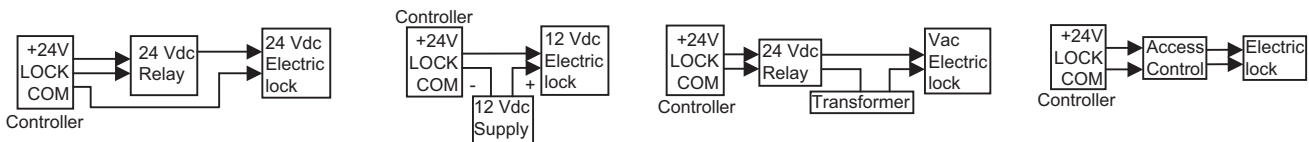

- Don't forget to set the Open Delay to delay the door opening until after the lock has had a chance to open.
- The controller drives the electric lock from when it receives a valid trigger (at Latch-Stop), while waiting to open (because of a non-zero Open Delay, or because the swing area is occupied) and until some time after the door has begun to open. It also drives it if the door reaches Latch-Stop as it is retriggered. The LOCK LED lights up while the controller drives an electric lock, whether or nor a lock is actually present.

Pair of Doors

Two openers may be used to open two side-by-side doors. The doors may be synchronized or not. This operator is not compatible with over-rebated doors.

Synchronized doors

The doors behave as if they are mechanically interconnected. In case of a presence at one door, both doors react identically. In case of an obstacle at one door, the other door stops too, though a bit afterwards.

Wiring:

- Connect the grounds of the two controllers together
- Connect the motion sensor to both controllers, in parallel

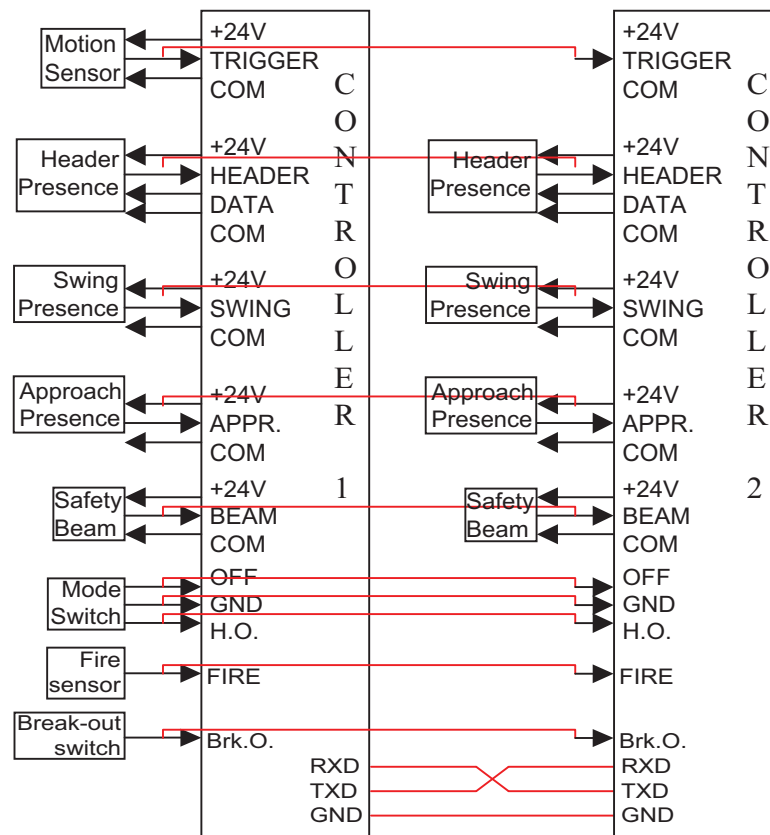

- Connect each presence sensor from each door to both controllers, in parallel (but not the DATA line)
- Let each controller power its presence sensors (either controller can power the motionsensor)
- Connect a single Program Switch to both doors, in parallel
- Connect the RXD line of each controller to the TXD line of the other controller
- If you use the “Fire” input, connect the fire sensor to both controllers.
- If you use the “Break-out” input, connect the break-out switch to both controllers.
- Power the controllers from the same AC power source

Set-up:

- Program the two controllers identically. However, in particular situations you may want to program them slightly differently, so that one door opens and/or closes first.
- Let the openers do a learn cycle (it's easier if you do them separately). Tip to stagger the opening of the doors during the learn cycle:
 - place both controllers in "Learn";
 - open one door;
 - as it's closing, flip the Program switch from Off to Auto;
 - the door that was still closed will start a learn cycle,
 - the one that you opened will first finish closing and then start a learn cycle.
 - this will give you a chance to stop the first door at Back-Stop, and then walk to the second door and stop it at Back-Check when it gets there a while later.
- When both openers are ready, trigger an automatic opening, and, as the doors are opening, block one of doors. When they start moving again, block the other one. This will let each opener tell the other of having detected an obstacle, so that each will know of the presence of a second door. Knowing that, the openers will extend the Hold-Open time after an obstacle, to ensure that both doors remain in synchronization afterwards.

Semi-independent doors

The doors open and close at the same time. However, if one opener reacts to a presence or an obstacle, the other door continues as nothing happened, so the two doors become un-synched. The door return to being synched only after there's no traffic long enough for both doors to return home. For coordinated doors (one must close first) it's possible that the doors will close in the wrong order. To let the door operate independently:

- Program the two controllers identically (for coordinated doors - one must close first - increase slightly the Closing Delay of the controller for the door that must close last)

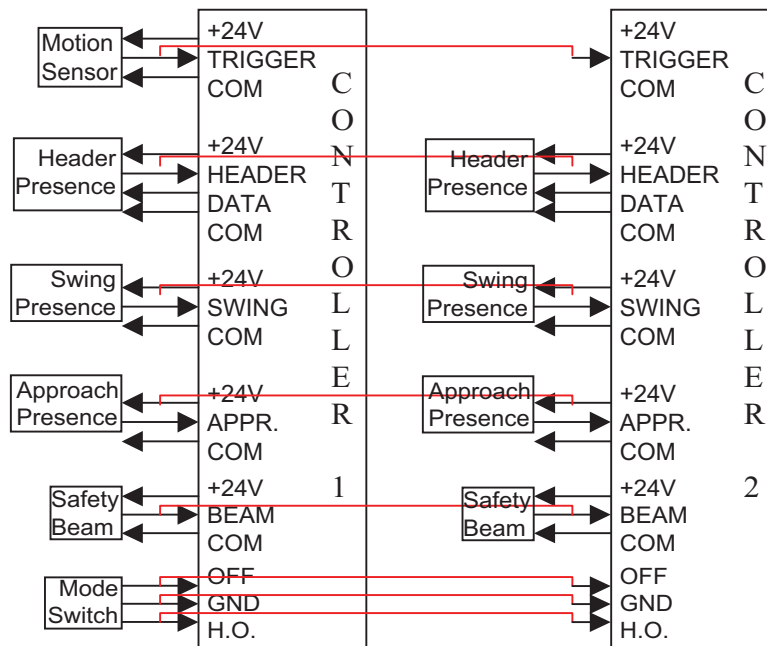

- Connect the grounds of the two controllers together
- Connect one door's presence sensors just to the controller for that door
- Connect the motion sensor to both controllers, in parallel
- Let each controller power its presence sensors (either controller can power the motion sensor)
- Connect a single Program Switch to both doors, in parallel
- Power the controllers from the same AC power source

OPERATION

Restore factory defaults

To reset the unit to the factory defaults, do the following:

- Turn the "Selector" knob to the "Misc Sel" position.
- Turn the "Dial" knob until "rSt" is shown in the display.
- Turn the "Selector" knob to the "Misc Adj" position. The display will show "nO".

Turn the "Dial" knob right. The display will show "yES" for just a split second, and the controller will restart.

Set-up without temporary stop

If for some reason you don't want stop the door at Electrical Back-Stop during set-up, use this alternate procedure:

- Manually open the door until it hits a mechanical stop (such as a wall or the operator's internal Hard-Stop). Measure that opening angle exactly.
- Turn on the controller
- Indicate the type of door opener and the door mount.
- Turn the "Selector" knob to the "Back-Stop" position. Use the Dial knob to change the Back-Stop angle to the angle you just measured.
- Turn the "Selector" knob to the "Learn" position.
- Set the Program Switch in the "Auto" position.
- The door will start opening slowly and hit the hard-stop.
- As the door closes slowly to Latch-Stop, turn the "Selector" knob to the "Back-Stop" position. Use the Dial knob to change the Back-Stop angle to the desired Electrical Back-Stop Angle (such as 90°).
- **Get out of the way!**
- The door will slam open to 45°, then close.
- The display will show "CyC", meaning that the opener needs a cycle learn.
- The door will cycle open and closed at normal speed once.

Cycle testing

To cycle test the operator, do the following:

- Apply AC power to the controller.
- Set the Program Switch in the "Off" position.
- Turn the "Selector" knob to the "Back-Stop" position. The display shows the programmed Back-Stop angle in degrees.
- Turn the "Dial" knob to adjust the programmed Back-Stop angle to the actual Back-Stop angle of the door.
- Turn the "Selector" knob to the "Learn" position. The display shows the Learn State. If it doesn't say "ALL" (meaning it needs a complete learn), turn the "Dial" knob counter-clockwise until it does.
- Set the Program Switch in the "Auto" position. The opener will start a learn:
 - The door will open slowly to Back-Stop.
 - The door will close slowly to Latch-Stop.
 - The door may slam partially open, then close.
 - The door will start cycling open and close, non stop. Note that the opener has limited obstacle detection while learning: do not stop the door!
- Turn the "Selector" knob to the "Mon Sel" position.
- Turn the "Dial" knob until that "CyC" (for Number of Cycles) is shown in the display.
- Turn the "Selector" knob to the "Monitor" position. The display will show the number of cycles. If there are more than 999 cycles, use the "Dial" knob to scroll the display.