

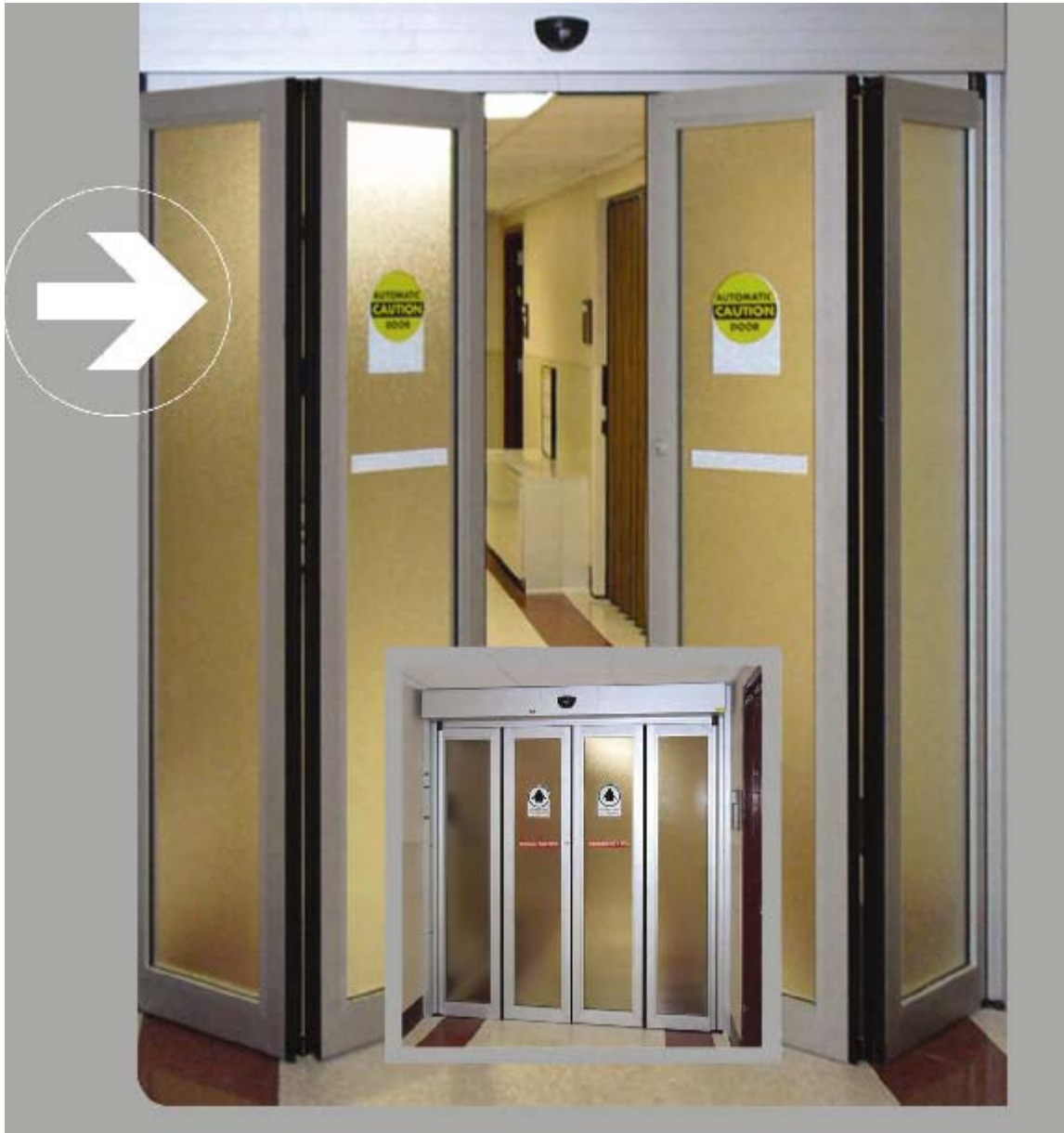

4500 Series Folding Door Installation Instructions





4500 Series Folding Door Installation Instructions

The record-usa 4500 slide/fold has been carefully designed, built, and tested to provide years of service.

The life of the door package is directly related to how carefully the installation is accomplished and how accurately the instructions are followed. Installation of this door package is to be performed by properly trained and experienced installers knowledgeable with local code requirements and all requirements of ANSI A156.10 Standards for Power Operated Pedestrian Doors. The authorized service / installation dealer must perform all measurements for forces, speeds, and times to insure proper and safe operation.

record-usa is not responsible for improperly adjusted or maintained automatic doors or activation / safety systems and assumes no responsibility for damages caused by automatic door systems that have not been properly installed, tested, and adjusted.

**NOTE: GLASS AND GLAZING ARE NOT INCLUDED IN THE PACKAGE.
THE GLAZING MATERIALS IN BOTH THE DOORS AND SIDELITES SHALL COMPLY WITH THE REQUIREMENTS IN THE AMERICAN NATIONAL STANDARD PERFORMANCE SPECIFICATIONS AND METHODS OF TEST FOR SAFETY GLAZING MATERIALS USED IN BUILDINGS, Z97.1.1975**

OWNER INFORMATION TO BE PROVIDED BY THE DISTRIBUTOR / INSTALLER

- * After the installation instruct the owner on the safe operation of the door.
- * Location and proper use of the power switches.
- * Location of the main cutoff breaker.
- * Necessary warnings not covered in general instructions.
- * Owners Manual and Daily Safety Checklist.
- * Phone number(s) for the local servicing dealer.
- * What to do in the event that a dangerous situation should occur, and how to shut the doors down and call for service.

TABLE OF CONTENTS

OWNER INFORMATION / TABLE of CONTENTS.....1
TOOL LIST / GENERAL REQUIREMENTS.....2
FRAME , HEADER AND DOOR CONFIGURATION 3
SETUP, CALIBRATION AND LOCKING.....4
DISPLAY PANEL CONTROL WIRING OPTIONS.....5
COMMISSIONING THE 4500 USING DISPLAY CONTROL...6
PARAMETER CONFIGURATIONS.....7,8
REMOTE CONTROL OF DOOR OPERATING MODE.....9
SIGNAGE REQUIREMENTS.....10
WIRE DIAGRAM – OPTEX SENSOR PACKAGE.....11
WIRE DIAGRAM - BEA SENSOR PACKAGE.....12
HEADER COMPONENTS.....13



4500 Series Folding Door Installation Instructions

TOOL LIST

- Knife
- 4' Level
- Hammer
- Chalk Line
- Wire Ties
- Wire Cutter
- Multi-Meter
- 4' or 6' Ladder
- Hammer Drill
- Tape Measure
- Electrical Tape
- Extension Cord
- 3/8" Cordless Drill
- Vise Grip Pliers
- Channel Lock Pliers
- Caulking & Gun
- Shim Material (shingles)
- Flat & Rat tail files
- Combination wrench set (standard & metric)
- Screwdrivers (#2 & #3 Philips, Sm. & Med.)
- Allen Hex wrench set (standard & metric)
- Ratchet & Socket set (standard & metric)
- Drill bit set up to 3/8" & 1/4" & 5/16" masonry bits
- 7/16" Fine tooth Ratchett Wrench
- 25mm Open End Wrench

GENERAL REQUIREMENTS

- Power: 120VAC, 60Hz., 15 Amp Service to terminal block in aluminum head section of door. Wiring to be in conformance with local codes and routed away from moving parts.
- Non-North American voltages can be 240VAC, if so be sure the operator has a 240VAC power supply.
- Power may be brought in through the top of the jamb on perimeter mount units or in through the back of surface mount units.
- For remote switch locations, routing of low voltage wiring to the operator controls will be required and there locations should be predetermined and wired before installation begins.
- Door Panels may be glazed before or after installation.

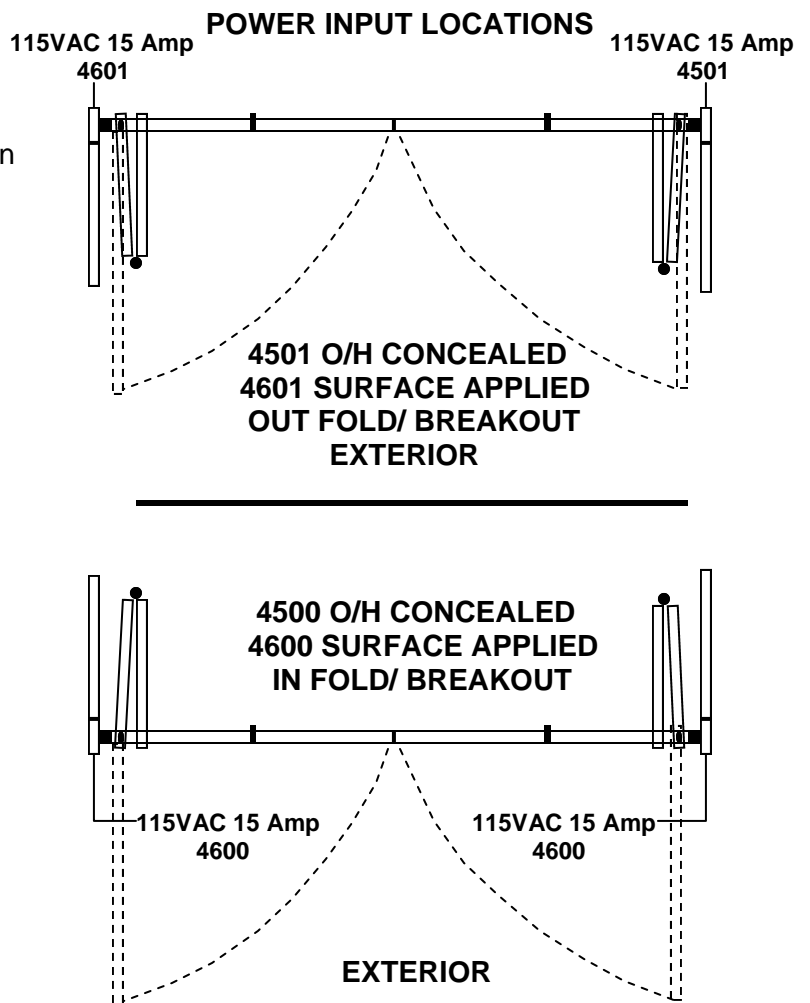



4500 Series Folding Door Installation Instructions

1. Verify rough opening dimensions are correct and square and floor is flat without high spots.
2. Attach jambs to Header with the 1/4-20 hex head bolts, lockwashers, and flat washers provided in the hardware pack using suggested 7/16" Ratchett wrench.. Attach safety beam harnesses and display control panel cable from jambs to Operator.
3. Install Header and jamb package in opening; shim as required to obtain level, plumb and square.

4. Use provided pivot template to locate and install floor mounted bottom pivots as seen to the right.

5. Snap jamb filler / fingerguard extrusion into jambs with offset towards exterior of unit.

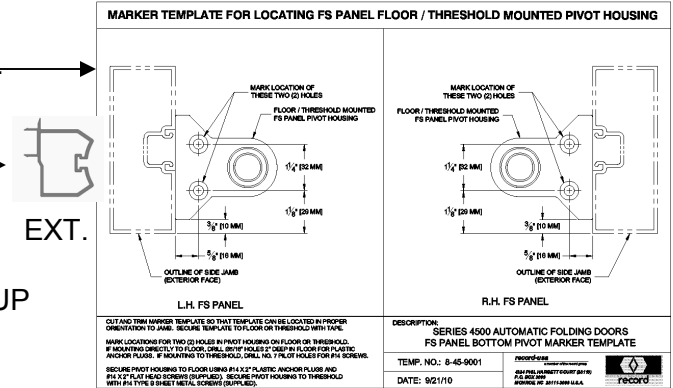

PIVOT TEMPLATE

6. Use operator belt to rotate top door arms to the door open position.
7. Remove nuts and bolts (2 each) from top door arm and panel endcap.
8. With Panel stood up in the open position, set onto floor pivot, then raise panel under door arm and reinstall hex head bolts into tapping plate. Loosen 3 bolts attaching door arms in top of door panel. Find correct set in the door closed position achieving the hard stop in the header and then retighten..
9. The Door panel should be tight up against the breakout member when it was fastened to the top arm. Use the operator belt to close panels and insure proper clearances. Loosen thin hex nut to lower door panel that it opens and closes without excessive drag against breakout member. (25mm)
10. After proper setting is achieved tighten hex locknut to the thin nut to maintain setting.
11. Proceed by insuring that bottom door pivot is seated to floor portion, then tighten the 2 Allen cap bolts in pivot stile.
12. Please see in picture at right, the adjustable hard stop indicated for the door open position.

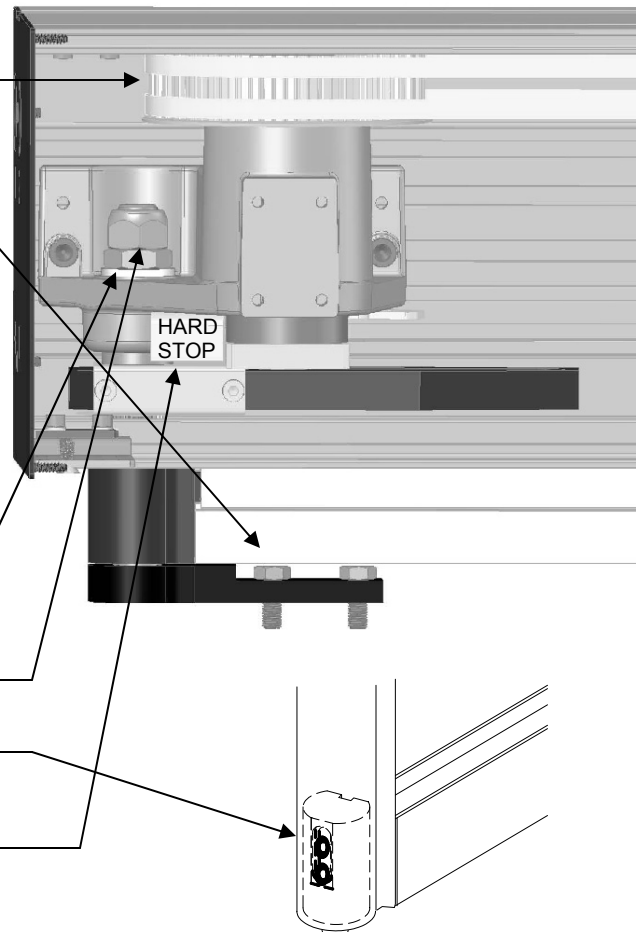



4500 Series Folding Door Installation Instructions

13. Remove 120VAC power cord from left hand end of power supply (refer to one of the attached wire diagrams in this booklet). Connect 120VAC Main Power to terminal block.

14. If onboard, connect standby battery to operator (disconnected for shipping). With doors in the open position, plug 120VAC power cord back into power supply. Unit should power up and close.

15. Proceed with the required Calibration run by holding down solid, the blue button on the circuit board for three flashes, and then one more time to cause an activation. Follow that with two more activations to complete entire calibration run. Process can also be achieved with FPC902 Programmer.

16. As a good operation has been achieved, proceed with the connections of push button actuators, sensors, etc., to either terminals 2 & 3 or 22 & 23. Note: when unit is placed in EXIT mode, terminals 2 & 3 are deactivated when door is closed.

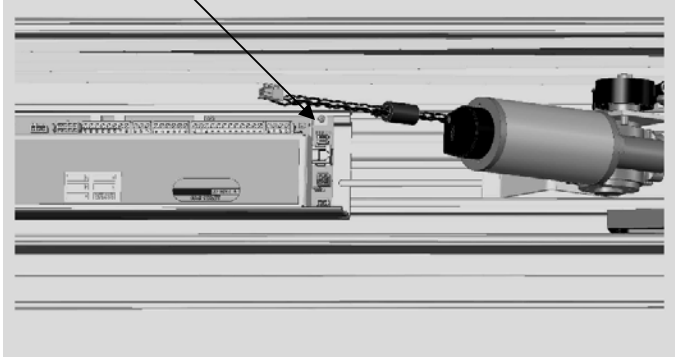
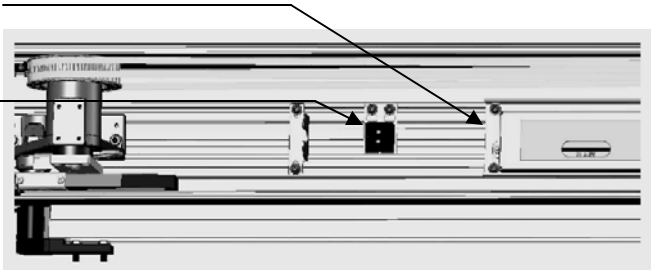

Locking:

The 4500 Slide/Fold has the options of obviously no electric lock, or one lock to lock the fold, or 2 locks to lock the fold and the breakout. Please see to the right in the illustrations, first, the belt lock which could potentially be attached to either the master pedestal or the slave pedestal. If this is provided alone, it would be connected to the main control board.

Please see in the second illustration, the lock for breakout which lands centered in the header to lock the breakout of both door panels. In the case of both lock types being used, there should also be an onboard battery backup system. The header should contain the documents for this application.

In the third and final illustration, please find the sequencing control if both lock types are on board. Typically will be located between the breakout lock and main control board, with a harness connecting the two. The center connection will be the breakout lock, and the remaining or left connector will be the belt lock or pedestal mounted. There are corresponding LEDs; 2 Green to the right showing power to the control, 2 Red in the center showing breakout at an idle, and 2 green to the left indicating belt lock at an idle.

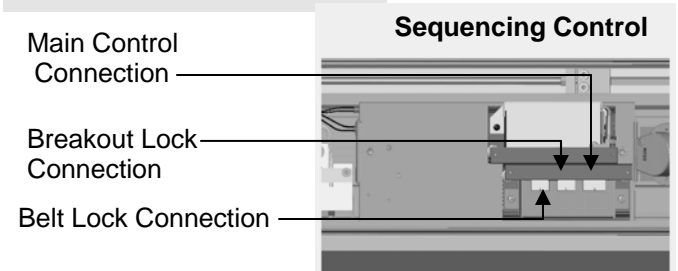
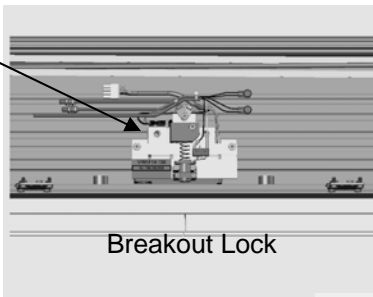
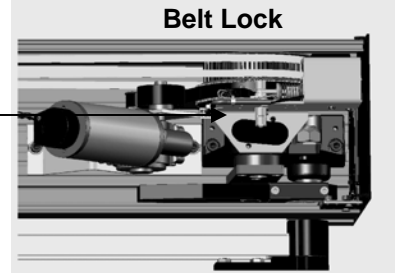



Series 4500 Display Panel Control Wiring Options

Aug11

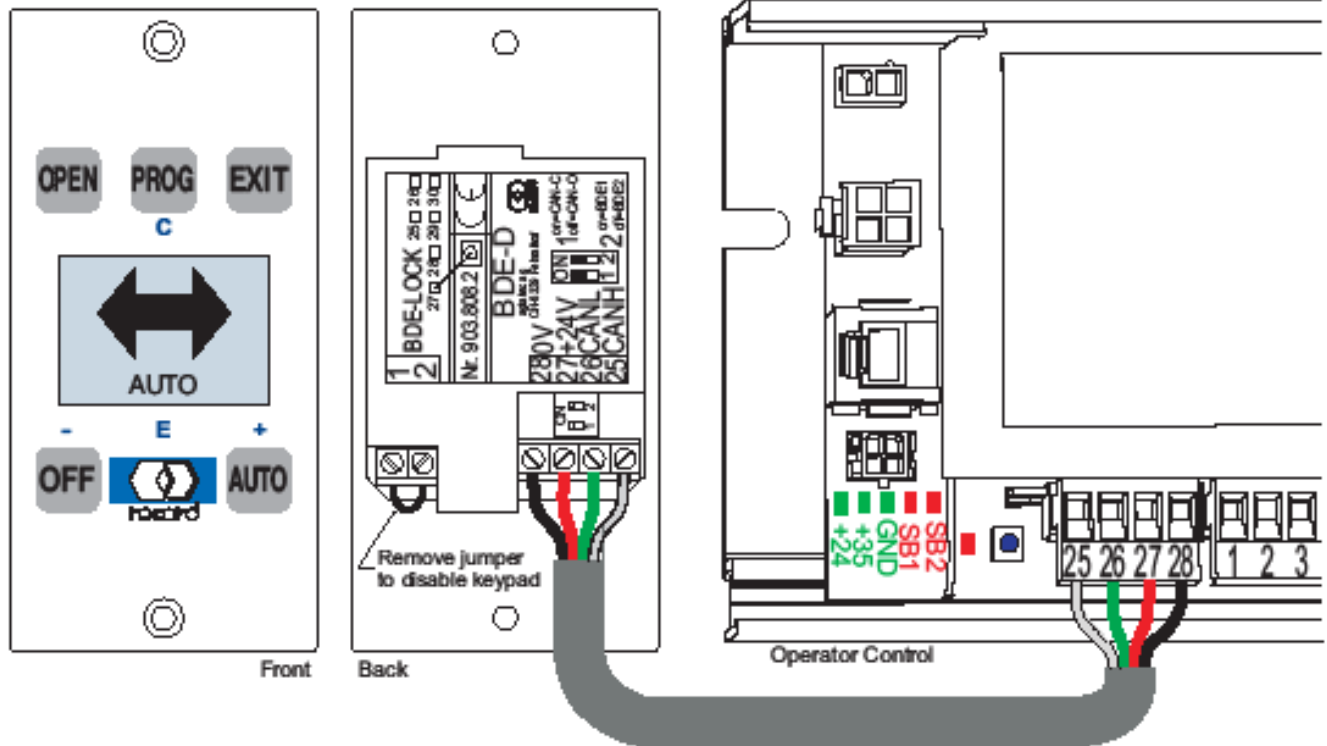

The Display Panel Control is connected to the Series 4500 Operator Control as shown and is typically mounted in the door jamb adjacent to the FS Panel. The unit may be remotely mounted as desired, and should always be in a location where the user can view the door. An optional enclosure is available for remote mounting (see image below right).

The keypad on the display can be disabled by removing the jumper located between screw terminals 1&2 on the back of the display (see above). A switch (SPDT) can be wired in place of the jumper and

When the keypad is disabled, a small key is displayed on the left of the screen. The unit will continue to display the current operating mode of the door and will exhibit any alarm condition that occurs, but the keypad will not function.

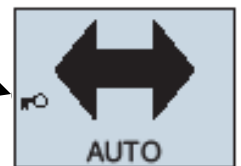

Two Display control Panels can be connected to a Series 4500 for mode control from two separate locations. The panels are wired in parallel, and dipswitch # 2 (above wire terminals 26&27) on one panel should be set to "OFF". Two mechanical switch assemblies (shown at right) are available for connection to a Series 4500 in addition to the Display Control Panel. The mounting template is identical to the display panel; the units can replace the display on the door. Refer to the Series 4500 wiring diagram for wiring. Note: When a mechanical panel is connected, it will have priority over the display panel when selecting operating mode.

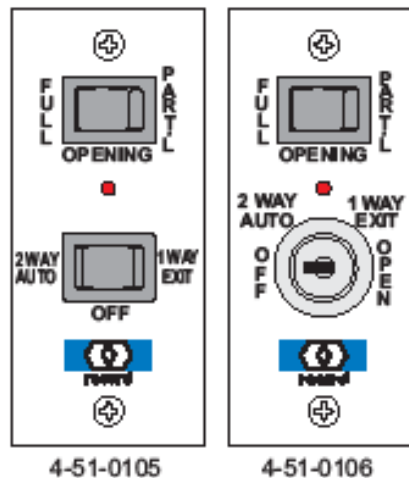

Optional Enclosure



Commissioning the Series 4500 using the Display Control

The Display Control Panel is a convenient input and output unit for the door system and programming of control units in record door openers. Logically arranged pushbuttons permit an intuitive operation of the door and navigation through the drive-specific menu structure. The backlit LCD display provides data and information regarding the status of the door using symbols and plain text messages. The connection to the door control is via the CAN bus built into the record products.

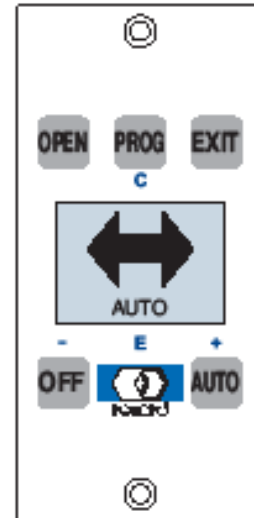

The technical specifications of the control panel are:

- Supply voltage: 24 VDC from CAN bus
- Connected load: < 2 W
- Dimensions: 1.74" X 3.63"
- Temperature range: 0°C to +50°C
- LCD display: 112 x 64 pixels (0.84" X 1.18"), with white backlight

In addition to providing the owner a method for selecting the door operating modes, the control panel can be used to access and adjust the door parameters. To enable this feature, first gain access to the door operator in the header, and locate the microprocessor control. On the lower left of the control are three green LEDs, 3 red LEDs, and a small pushbutton (Control Switch Button). The pushbutton performs multiple functions depending upon how long it is pressed, as indicated by the adjacent red LED.

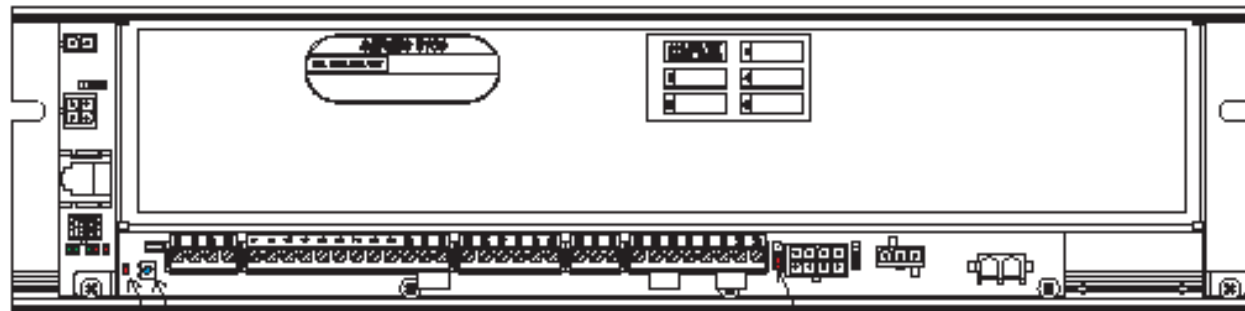

Control LED → Control Switch Button

Direction Select Jumper

Pressing and holding the button causes the adjacent red Control LED to pulse "on" approximately once per second. The number of pulses determines the resulting effect:

- 1 pulse simulates the actuation of the interior sensor and initiates a door cycle.
- 2 pulses initiates an automatic acquisition of safety beam and battery characteristics.
- 3 pulses initiates a door learn mode where the door weight and friction are learned.
- 4 pulses initiates a configuration mode where the Display Control Panel has access to the microprocessor control parameters.
- 8 pulses resets the microprocessor parameters to the factory defaults.
- 12+ pulses performs a complete hardware reset.

Typically, during a new installation, the microprocessor will have already been set at the factory for the door opening, **but the completed installation will require a calibration mode initiated by holding the Control Switch Button down for three pulses of the Control LED. Calibration will occur during the next three door cycles, which should be initiated immediately.**

If additional changes to the door operation are desired, then proceed to the next section.

Parameter Configurations

Press and hold the Control Switch button for 4 pulses of the adjacent red Control LED.
The Control Panel Display will change from current operator mode to configuration mode -

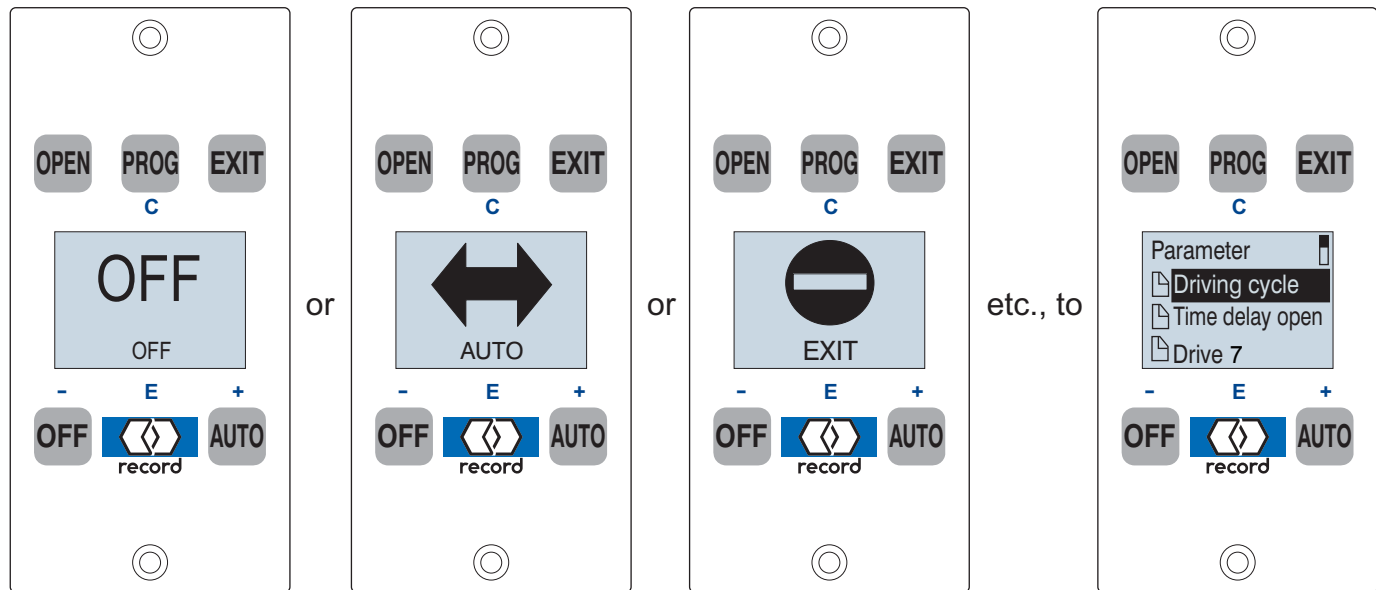

In this mode, the top center "PROG" switch and bottom three switches are used to select and modify the door parameters. Note the small blue legends next to each switch indicates its use in the configuration mode -

Use the "+" (AUTO) switch to scroll down menus, or increase individual parameter values.

Use the "-" (OFF) switch to scroll up menus, or decrease parameter values.

Use the "E" (record) switch to select the currently selected parameter or parameter value.

Use the "C" (PROG) switch to revert to the previous screen.

The various parameters are distributed in menus and sub-menus in the following order:

Driving Cycle -

Closing Speed (12 inches per sec. max.)

Opening Speed

Acceleration

Time Delay Open - 60 seconds maximum

TD Open (for sensor actuation)

TD Remote Switch

Drive -

Partial Open - 8 in. minimum

Reverse Adjust - More sensitive (default) or Less sensitive

Emergency Open / Close - normally disabled

Power Failure - optional for battery backup

Entrance System -

Door Type (always select Breakout-USA)

Control Panel -

Mechanical Panel (typically disabled), and Display Panel

Note several options are available for the Display Panel -

Language (English US), Keyboard (Off), Contrast, and Time Delay - Backlite (seconds)
(TD Backlite=0 turns off the backlight; TD Backlite=40 is always on)

Locking -

Locking Function - Manual, Night locked, 1-Way locked, Always locked

Lock Type - Without lock, Motor powered, **BiStable**, MPU, Magnet, **Double**
Fail Secure, and Fail Safe (North American options underlined)

Input -

Exterior Switch Input - always select "Ext. Sw IN" (as required by ANSI A156.10)

Emergency Open / Close - typically disabled

Auxiliary Switch - disabled, Safety Beam (other than builtin unit), Sidescreen Sensor,
CO48 (North American options underlined)

Output -

Alarm - will actuate auxiliary relay contacts when an alarm mode occurs



Gong - will actuate auxiliary relay contacts when safety beam is interrupted

Miscellaneous -

TOWA - If door is in Partial Open mode and traffic occurs in both directions,
or occurs for more than 10 seconds, door temporarily fully opens.

To exit the parameter adjust mode, press the "C" (PROG) multiple times until the "Exit Program Mode - NO / YES" screen appears, then press the "E" record switch to exit.





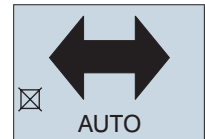









Note; If no switch is pressed for 3 minutes, the Program mode is automatically exited.

The control panel can be "locked", preventing unauthorized use, by pressing the key sequence -  +  +  A small square with an "X" will appear on the left of the display. To re-enable the keypad, repeat the above sequence.



Entering a custom telephone number for the error screens is accessible only through using an FPC902 Flash Programmer / Hand Terminal. See its instructions for further details.

The following are examples of Alarm screens that may appear, indicating an abnormal door status:

 63 Obstruction	The door has encountered an obstruction, either in opening or closing, which requires more power than allowed by code.	 14 Alok Mon. Sw VAK fault	The monitor switch on the automatic lock is providing a signal which does not correlate with expected lock status. Also check wiring to switch.
 31 EMERGENCY STOP/BREAKOUT	One of the door panels has been broken out, and not fully reset into its closed position. Also check for a damaged panel cutoff switch.	 10 Locking error	The automatic lock is not properly engaging and locking the sliding motion of the door. Check mechanical alignment.
 59 Safety Beam ELS active>60s	One or more of the safety beams has been obstructed for more than 60 seconds. Also check for damaged wiring to beam heads.	 6 Unlocking error	The automatic lock is not unlocking and releasing the door to slide open. Check mechanical alignment.
 5 Exterior Sensor AKA active>60s	The sensor / switch connected to terminals 2 & 3 has been actuated for more the 60 seconds. Also check wiring for damage.	 43 Encoder fault	The signals from the encoder on the motordrive do not correlate with operator drive mode. Check wiring & connectors between motor & control.
 3 Interior Sensor AKI active>60s	The sensor / switch connected to terminals 22 & 23 has been actuated for more than 60 seconds. Also check wiring for damage.	 62 Control panel can't override	A second mechanical control panel or a remote control station has been connected and has priority over the Display control panel.
 61 Remote Sw. SSK active>60s	The sensor / switch connected to terminals 13 & 14 has been actuated for more than 60 seconds. Also check wiring for damage.	 2 Manual locked	The door has been locked from a remote control station and the Display control panel cannot override.
 47 Aux. Sensor SHE active>60s	The sensor / switch connected to terminals 5 & 6 has been actuated for more than 60 seconds. Also check wiring for damage.	 37 Motor current	The motor current is outside of allowable values (too low or too high) and the control has ceased automatic operation.



Series 4500 – Remote Control of Door Operating Mode

Enter the *parameter adjust* mode at the operator control module and, using the Display control panel, scroll down to and select the “**Control Panel**” parameter. Select “**Mech. Panel**”, scroll down to and select “**One-way**” (factory default is “**disabled**”). Exit *parameter adjust* mode. The *door operational* mode will now be “**Off**” until a jumper is placed between terminals 15 and 16 on the operator control module.

Remote Control of Automatic / Exit Only modes only –

A single set of dry contacts (rated 0.2A minimum) is required and connected between terminals 15 and 17 on the operator control module. When the contact is open, the door will be in “**Automatic**” mode; when the contact is closed, the door will be in “**Exit**” only mode, and the exterior sensor (connected to terminal 23) is disabled when the door is fully closed. As required by code, the exterior sensor will be active when the door is open and/or closing.

Remote Control of Automatic / Exit Only / Open / Off (or Locked) modes –

Two sets of dry contacts are required. One set will be connected between 15 and 17 as above, and the second set will replace the jumper between 15 and 16. The following table lists the *door operational* mode as defined by the contacts:

<u>Mode</u>	<u>Contact 15/16</u>	<u>Contact 15/17</u>
Off	Open	Open
Automatic	Closed	Open
Exit Only	Closed	Closed
Full Open	Open	Closed

The door, if supplied with electric locking, will have either a stand alone belt lock or double locking which also locks the breakout. If double locking is provided, there will be an onboard battery backup to keep the door operating in the case of a power failure because of the lock types being bistable. The lock or locks will be operating in the Automatic and Exit modes. Setting the unit to Exit only mode will be disabling the Exterior activation but not altering the locking function.

Note: Priority between the remote contacts and the Display control panel follows a safety / security tier. If either is *Off* (or *Locked*), the door will be “**Off**” (“**Lock**”). If the remote contacts are set for *Automatic* mode, the Display control panel has full functionality. If the remote contacts are set for *Exit Only*, only the Display’s *Off* and *Exit* buttons function. If the remote contacts are set for *Open*, only the Display’s *Off*, *Exit*, and *Open* buttons function.

Make sure that all doors have proper signage as follows:

IN EMERGENCY PUSH TO OPEN

Figure 1



Figure 2



Figure 3



Figure 4

Folding doors shall be provided with a sign reading "IN EMERGENCY PUSH TO OPEN" (Figure 1) mounted on the FX panel applied to the side appropriate for egress. The sign shall have red background with contrasting letters 1 inch (25 mm) high minimum. The sign shall read horizontally and be located adjacent to the lock stile on a center line 36 inches (915 mm) minimum and 60 inches (1525 mm) maximum from the floor. An international "DO NOT ENTER" sign (Figure 3) shall be applied to the appropriate side of the FX panel as determined by traffic flow. If folding doors are being used in pairs, each FX panel is required to have signs.

For one way traffic folding doors, an arrow sign (Figure 2) shall be visible from the approach side of a folding door mounted on the door at a height 58 inches \pm 5 inches (1475 mm \pm 125 mm) from the finished floor to the center line of the sign on the FX panel. The sign shall be a minimum of 6 inches (150 mm) in diameter, having a green circle surrounding a black arrow on a white background. On the non-approach side, the international "DO NOT ENTER" sign (Figure 3) shall be visible. If folding doors are being used in pairs, each FX panel is required to have signs.

Folding doors serving both egress and ingress shall be marked with an arrow sign (Figure 2) visible from the non-fold side. The fold side shall be marked with the "AUTOMATIC CAUTION DOOR" sign (Figure 4).

"Knowing Act Doors" shall have signage which says "AUTOMATIC DOOR - ACTIVATE SWITCH TO OPERATE" in $\frac{1}{2}$ inch (13 mm) high letters along with other required signage visible from each side of the door.

Install all signage in accordance with the requirements described ANSI/BHMA Standard A156.10 - 1999. Make sure all appropriate signage is applied to the door.

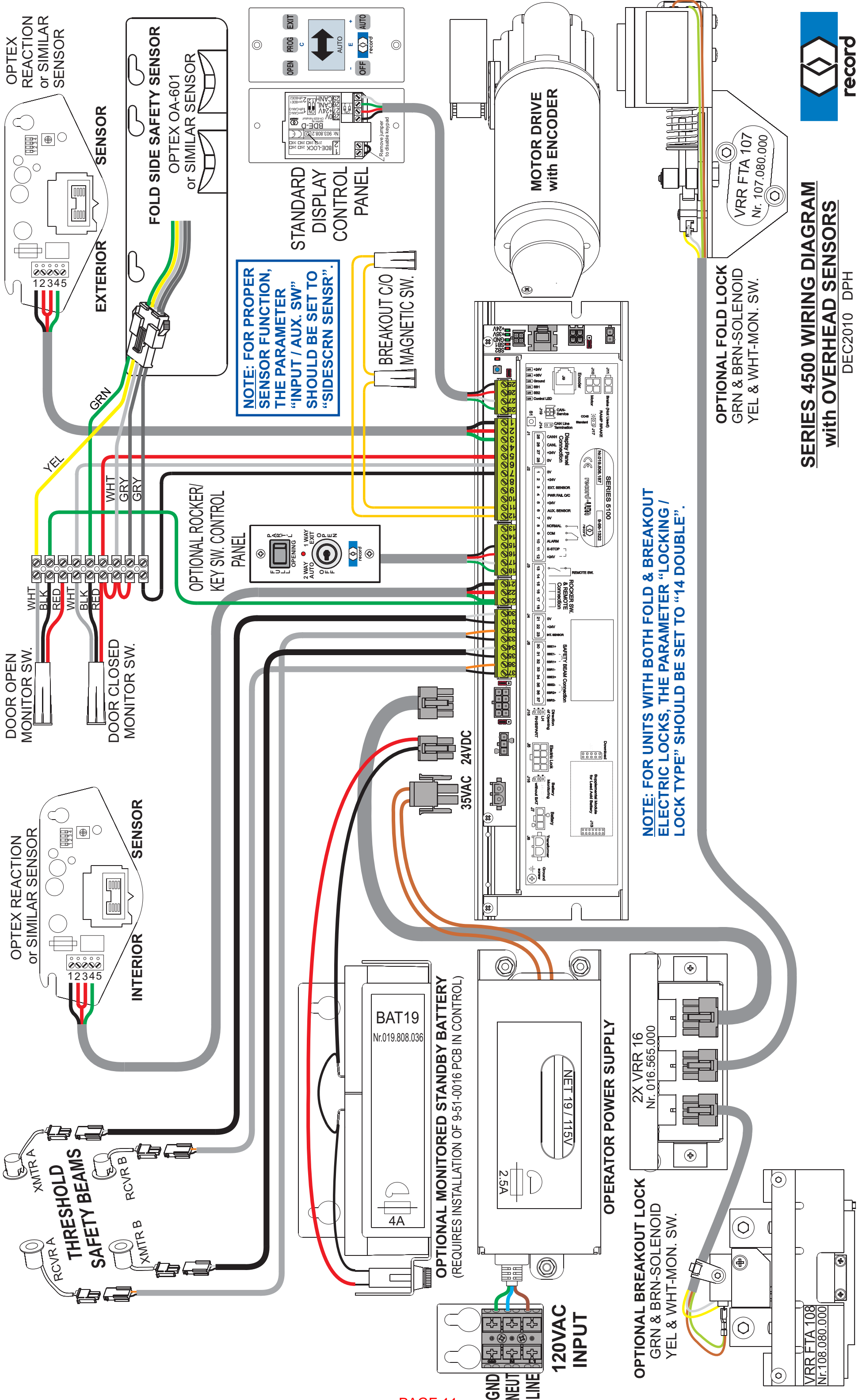

NOTE: FOR PROPER SENSOR FUNCTION, THE PARAMETER "INPUT / AUX. SW" SHOULD BE SET TO "SIDESCRN SENSOR".

NOTE: FOR UNITS WITH BOTH FOLD & BREAKOUT ELECTRIC LOCKS, THE PARAMETER "LOCKING / LOCK TYPE" SHOULD BE SET TO "14 DOUBLE".

SERIES 4500 WIRING DIAGRAM
with OVERHEAD SENSORS

DEC2010 DPH



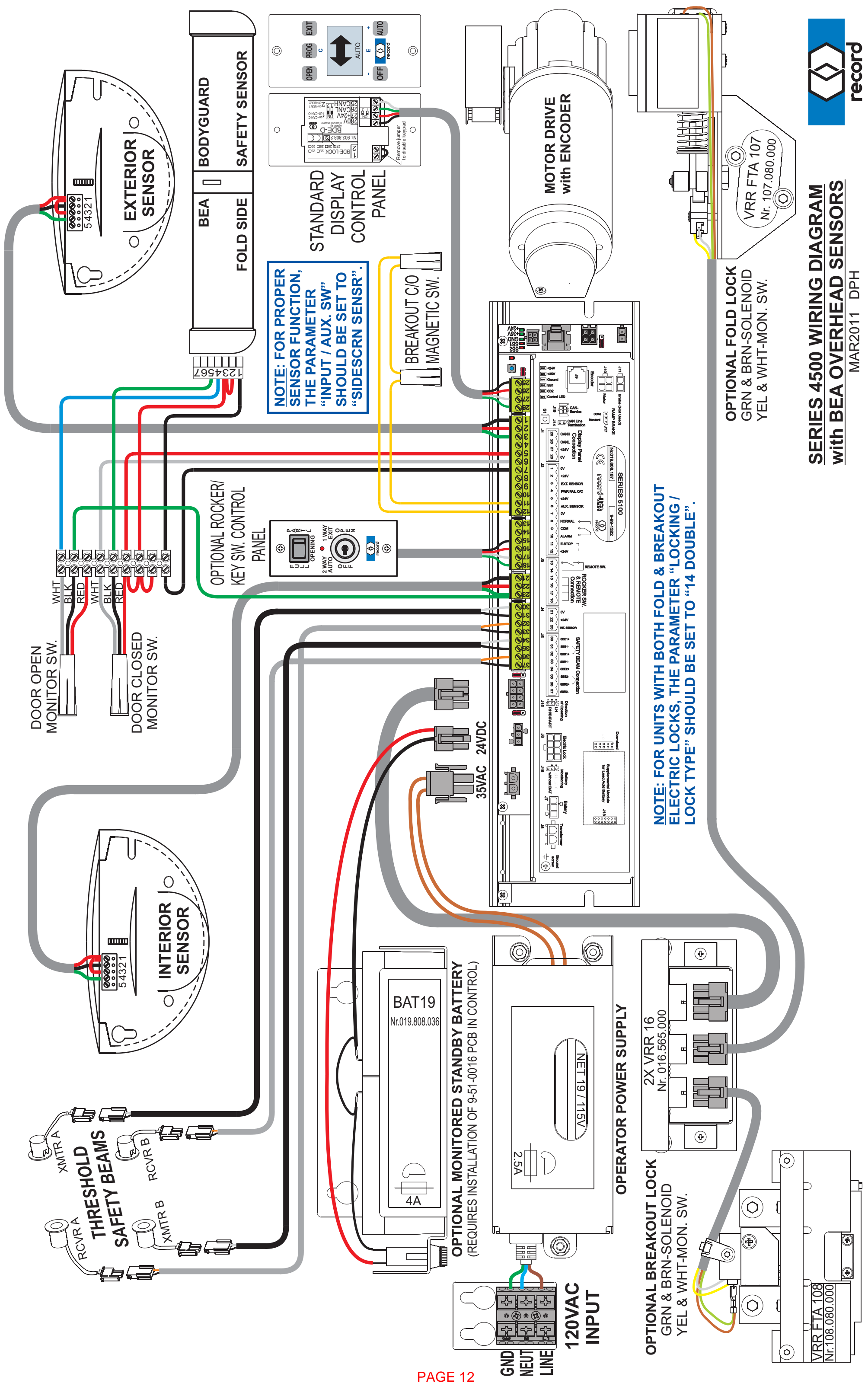

NOTE: FOR PROPER SENSOR FUNCTION, THE PARAMETER "INPUT / AUX. SW" SHOULD BE SET TO "SIDESCRN SENSOR".

NOTE: FOR UNITS WITH BOTH FOLD & BREAKOUT ELECTRIC LOCKS, THE PARAMETER "LOCKING / LOCK TYPE" SHOULD BE SET TO "14 DOUBLE".

**SERIES 4500 WIRING DIAGRAM
with BEA OVERHEAD SENSORS**

MAR2011 DPH



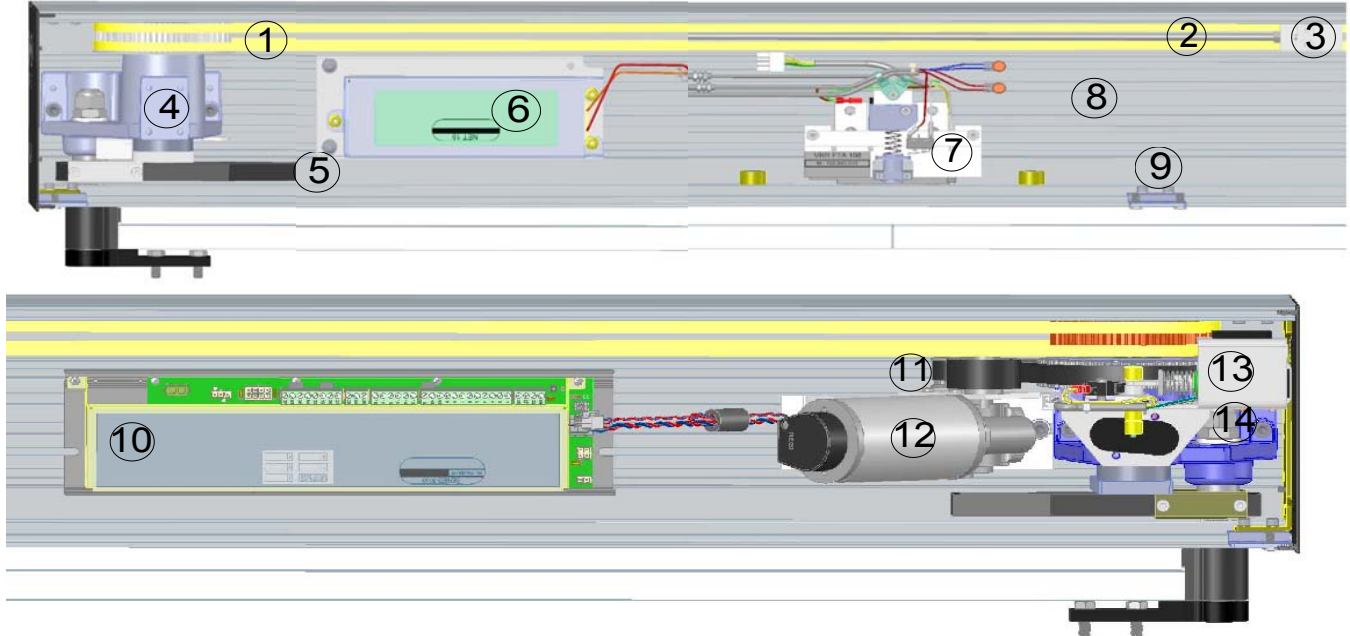

ITEM	PART NUMBER	DESCRIPTION	QTY.	LIST PRICE
1	9-09-0015	BELT, MAIN DRIVE	2	
2a	9-45-0011	TIE ROD, BELT CLAMP, SHORT	1	
2b	9-45-0013	TIE ROD, BELT CLAMP, LONG	1	
3a	9-45-0010	BELT CLAMP, RIGHT	1	
3b	9-45-0012	BELT CLAMP, LEFT	1	
4	9-45-0101	DRIVE PEDESTAL, SLAVE	1	
5	9-45-0103	INNER ARM ASSY.	2	
6	4-45-0014	MODULE, POWER SUPPLY	1	
7	9-45-0106	* ELECTRIC LOCK, ANTI-BREAKOUT	1	
8	5-45-4001	HEADER EXTRUSION, FOLDER, CL-DB	~	
	5-45-4002	COVER EXTRUSION, FOLDER HEADER, CL-DB	~	
	4-45-1001	BRACKET, HEADER TO JAMB	2	
	4-45-1002	END CAP, HEADER	2	
9	4-45-1003	BRACKET, COVER ATTACHMENT	4	
10	9-99-1322	CONTROL, SERIES 5100 w/fold software	1	
11	9-09-0014	BELT, MOTORDRIVE ASSY.	1	
12	9-45-0104	MOTORDRIVE ASSY.	1	
13	9-45-0105	* ELECTRIC LOCK, DRIVE PEDESTAL	1	
14	9-45-0102	DRIVE PEDESTAL, MASTER	1	
* IF BOTH LOCKS ARE BEING USED, THE FOLLOWING CONTROL WILL BE NEEDED FOR SEQUENCING				
	9-45-0108	CONTROL, ELECTRIC LOCKS	1	